



Tutorial: Environment for Tree Exploration

Release 2.3.6

Jaime Huerta-Cepas

August 11, 2015

1	Changelog history	3
1.1	What's new in ETE 2.3	3
1.2	What's new in ETE 2.2	5
1.3	What's new in ETE 2.1	9
2	The ETE tutorial	13
2.1	Working With Tree Data Structures	13
2.2	The Programmable Tree Drawing Engine	43
2.3	Phylogenetic Trees	63
2.4	Clustering Trees	80
2.5	Phylogenetic XML standards	85
2.6	Interactive web tree visualization	92
2.7	Testing Evolutionary Hypothesis	94
2.8	Dealing with the NCBI Taxonomy database	104
2.9	SCRIPTS: orthoXML	108
3	ETE's Reference Guide	115
3.1	Master Tree class	115
3.2	Treeview module	127
3.3	PhyloTree class	137
3.4	Clustering module	140
3.5	Nexml module	142
3.6	Phyloxml Module	157
3.7	Seqgroup class	160
3.8	WebTreeApplication object	161
3.9	EvolTree class	161
3.10	NCBITaxa class	166
	Bibliography	169
	Python Module Index	171
	Index	173

[Download PDF documentation] ||

Changelog history

1.1 What's new in ETE 2.3

1.1.1 Update 2.3.2

- added `NCBITaxa.get_descendant_taxa()`
- added `NCBITaxa.get_common_names()`
- `ete ncbiquery`: dump descendant taxa given a taxid or taxa name. new option `'-descendants'`; renamed `'-taxonomy'` by `'-tree'`
- fixes <misaligned branches <<https://github.com/jhcepas/ete/issues/113>>' in ultrametric tree images using `vt_line_width > 0`
- fixes <windows installation problem <<https://github.com/jhcepas/ete/issues/114>>'

1.1.2 New Modules

tools

A collection of **command line tools**, implementing common tree operations has been added to the ETE core package. All tools are wrapped by the `ete` command, which should become available in your path after installation.

- `ete build`: Build phylogenetic trees using a using a number of predefined built-in gene-tree and species-tree workflows. [Watch example](#)
- `ete view`: visualize and generate tree images directly form the command line.
- `ete compare`: compare tree topologies based on any node feature (i.e. name, species name, etc) using the Robinson-Foulds distance and edge compatibility scores.
- `ete ncbiquery`: query the ncbi taxonomy tree directly from the database.
- `ete mod`: modify tree topologies directly from the command line. Allows rooting, sorting leaves, pruning and more
- `ete annotate`: add features to the tree nodes by combining newick and text files.
- `ete generate`: generate random trees, mostly for teaching and testing

ncbi taxonomy

The new **ncbi_taxonomy** module provides the class *NCBITaxa*, which allows to query a locally parsed NCBI taxonomy database. It provides taxid-name translations, tree annotation tools and other handy functions. A brief tutorial and examples on how to use it is available [here](#)

1.1.3 New features

News in Tree instances

- added *TreeNode.iter_edges()* and *TreeNode.get_edges()*
- added *TreeNode.compare()* function
- added *TreeNode.standardize()* utility function to quickly get rid of multifurcations, single-child nodes in a tree.
- added *TreeNode.get_topology_id()* utility function to get an unique identifier of a tree based on their content and topology.
- added *TreeNode.expand_polytomies()*
- improved *TreeNode.robinson_foulds()* function to auto expand polytomies, filter by branch support, and auto prune.
- improved *TreeNode.check_monophyly()* function now accepts unrooted trees as input
- Default node is set to blank instead of the “NoName” string, which saves memory in very large trees.
- The branch length distance of root nodes is set to 0.0 by default.
- newick export allows to control the format of branch distance and support values.
- Tree and SeqGroup instances allow now to open gzipped files transparently.

News in the treeview module

- improved SVG tree rendering
- improved *random_color()* function (a list of colors can be fetch with a single call)
- improved *SeqMotifFace*
- Added *RectFace*
- Added *StackedBarFace*

1.1.4 Highlighted Bug Fixes

- **Newick parser** is now more strict when reading node names and branch distances, avoiding silent errors when parsing node names containing illegal symbols (i.e. `]](,:)`)
- fixes several minor bugs when retrieving extra attributes in *PhyloNode.get_speciation_trees()*.
- Tree viewer **crashes** when redrawing after changing node properties.
- fixed **installation problem** using pip.

- visualizing internal tree nodes as a circular tree [produce crashes](#)
- [math domain error](#) in `SequencePlotFace`.
- Fix likelihood calculation bug in `EvolTree`
- Fix `BarChartFace` problem with negative numbers
- Fix problem that produced `TreeStyle` attributes to be ignored in `PhyloTree` instances.

1.2 What's new in ETE 2.2

1.2.1 BUGFIXES

- Fixes in NeXML parser and exporting functions
- Fixed 'paste newick' functionality on the GUI
- Fixed `PhyloNode.is_monophyletic()` and moved to `TreeNode.check_monophyly()`.
- Fixed consistency issued in `TreeNode.sort_descendants()` function.

1.2.2 SCRIPTS

- Improvements in the standalone visualization script (a.k.a. `ete2`)
- Added the `tree2orthoxml` script, which provides conversion between phylogenetic tree and the orthoXML format

1.2.3 NEW MODULES

- New `EvolNode` tree object type is available as a part of adaptation-test extension recently developed by François Serra (see [Testing Evolutionary Hypothesis](#) in the tutorial).

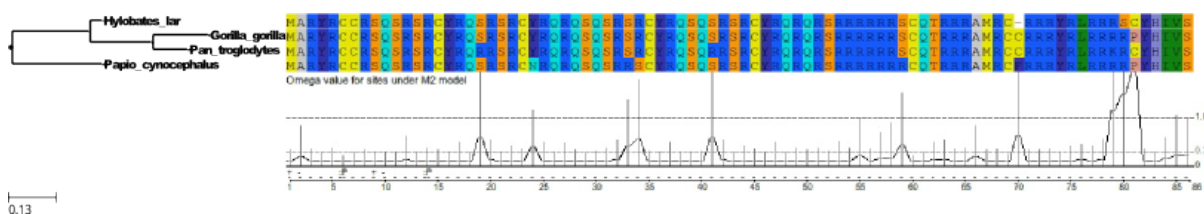

1.2.4 NEW FEATURES

- **News in core Tree instances:**
 - Added `TreeNode.robinson_foulds()` distance to compare the topology of two trees (i.e. `tree.robinson_foulds(tree2)`). It includes automatic pruning to compare trees of different sizes. *See tutorial and examples*
 - Added new options to `TreeNode.copy()` function, allowing faster methods to duplicate tree node instances. *See tutorial and examples*

- Added `preserve_branch_length` argument to `TreeNode.prune()` and `TreeNode.delete()`, which allows to remove nodes from a tree while keeping original branch length distances among the remaining nodes.
- Added `TreeNode.resolve_polytomy()` function to convert multifurcated nodes into an arbitrary structure of binary split nodes with distance. *See tutorial and examples*
- Added `TreeNode.get_cached_content()` function, which returns a dictionary linking each node instance with its leaf content. Such a dictionary might be used as a cache to speed up functions that require intensive use of node traversing. *See tutorial and examples*
- Improved `TreeNode.get_ascii()` function for text-based visualization of trees. A new `attributes` argument can be passed to display node attributes within the ASCII tree representation.

```
from ete2 import Tree
t = Tree("((A, B)Internal_1:0.7, (C, D)Internal_2:0.5)root:1.3;", format=1)
t.add_features(size=4)
print t.get_ascii(attributes=["name", "dist", "size"])
#
#                               /-A, 0.0
#                               /Internal_1, 0.7
#                               |           \-B, 0.0
# -root, 1.3, 4
#                               |           /-C, 0.0
#                               \Internal_2, 0.5
#                               \-D, 0.0
#
```

- Random branch length and support values generation is now available for the `TreeNode.populate()` function.
- a new argument `is_leaf_fn` is available for a number of traversing functions, thus allowing to provide custom stopping criteria when browsing a tree. This is, any node matching the function provided through the `is_leaf_fn` argument will be temporarily considered as a terminal/leaf node by the traversing function (tree will look as a pruned version of itself). *See tutorial and examples*
- Added `TreeNode.iter_ancestors()` and `TreeNode.get_ancestors()` functions.
- Added `TreeNode.iter_prepostorder()` tree node iterator.
- Newick parser accepts now the creation of single node trees. For example, a text string such as `"node1;"` will be parsed as a single tree node whose name is `node1`. By contrast, the newick string `(node1);` will be interpreted as an unnamed root node plus a single child named `name1`.
- `TreeNode.write()` accepts now a `format_root_node` argument to export root node features as a part of the newick string.
- The new `TreeNode.check_monophyly()` method allows to check if a node is mono, poly or paraphyletic for a given attribute and values (i.e. grouped species). Although monophyly is actually a phylogenetic concept, the idea can be applied to any tree, so any topology could be queried for the monophyly of certain attribute values. If not monophyletic, the method will return also the type of relationship connecting the provided values (para- or poly-phyletic). *See tutorial and examples*

- New `TreeNode.get_monophyletic()` method that returns a list of nodes in a tree matching a custom monophyly criteria.

- **News PhyloTree instances:**

- Added `PhyloNode.get_speciation_trees()` method, which returns all possible species topologies present in a gene family tree as described in Treeko. *See tutorial and examples*

See also:



TreeKO: a duplication-aware algorithm for the comparison of phylogenetic trees.

Marcet-Houben M, Gabaldón T.

Nucleic Acids Res. 2011 May;39(10):e66. doi: 10.1093/nar/gkr087.

- Added `PhyloNode.split_by_dups()` method, which returns a list of partial subtrees resulting from splitting a tree at duplication nodes. *See tutorial and examples*
- Added `PhyloNode.collapse_lineage_specific_expansions()` method, which returns a pruned version of a tree, where nodes representing lineage specific expansions are converted into a single leaf node. *See tutorial and examples*

- **News on sequence and multiple sequence alignment parsing:**

- added the option to disable the automatic correction of duplicated names when loading `SeqGroup` data from phylip and fasta files.

- **News on tree visualization and image rendering:**

- node style attributes can now be modified without the need of initialization by directly accessing the `TreeNode.img_style` attribute.
- Multiple layout functions can now be provided to combine their functionality. This way, you can keep separate styling templates and combine them as necessary.

```
from ete2 import TreeStyle

def color_leaves(node):
    if node.is_leaf():
        node.img_style["fgcolor"] = "red"

def size_internal(node):
    if not node.is_leaf():
        node.img_style["size"] = 15

ts = TreeStyle()
# provide a list of layout functions, instead of a single one
ts.layout_fn = [color_leaves, size_internal]
```

- `COLOR_SCHEMES` and `SVG_COLORS` dictionaries are provided for easy access to color codes and several predefined color schemes. In addition, a `random_color()` function is also available as a generator of RGB colors (where saturation and lightness can be fixed).

```

from ete2 import random_color, COLOR_SCHEMES, SVG_COLORS

# generate 20 random colors
node_colors = [random_color(s=0.4, l=4) for i in xrange(20)]
    
```

- **News on node faces:**

- New `face.rotation` attribute, that allows to rotate individual faces even when a global `treestyle.rotation` is used.

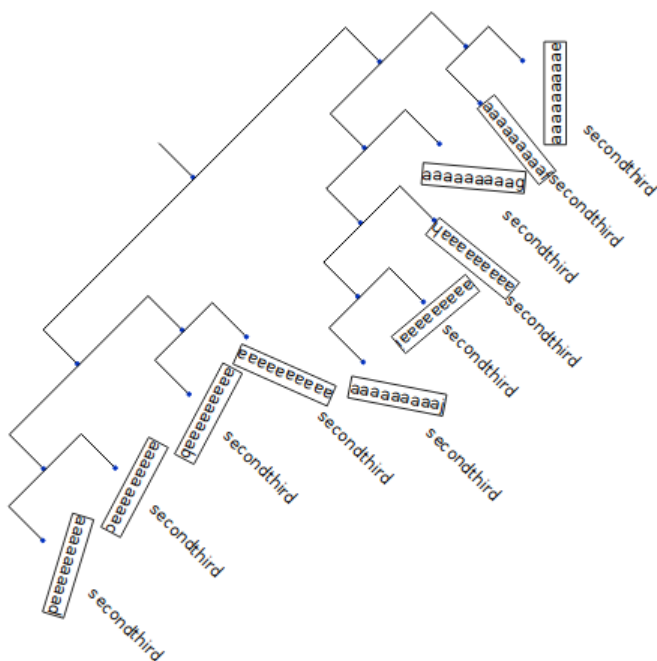

- Improved *SequenceFace*: Sequence sites are now rendered one by one, allowing interaction with each of them and getting rid of the previous pixmap size limitation. Site image dimensions and colours are now configurable.
- Added new *SeqMotifFace* class, which represent an enriched version of the former *SequenceFace* instance. This new face type allows to represent sequences as a succession of domain/motif elements or to represent sequence positions as color points. Gaps can also be taken into account and therefore shown as as a black space or a flat line.

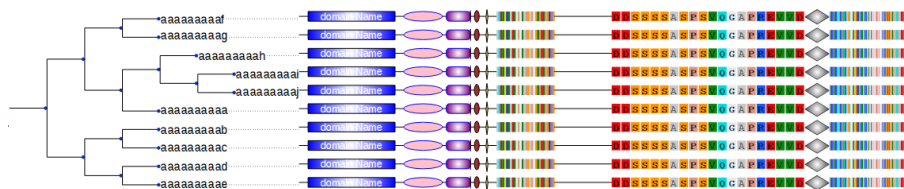

- Added *PieChartFace* and *BarChartFace* face types for built-in representation of statistics attached to nodes.
- Improved *ImgFace* class, now accepting on the fly image scaling.

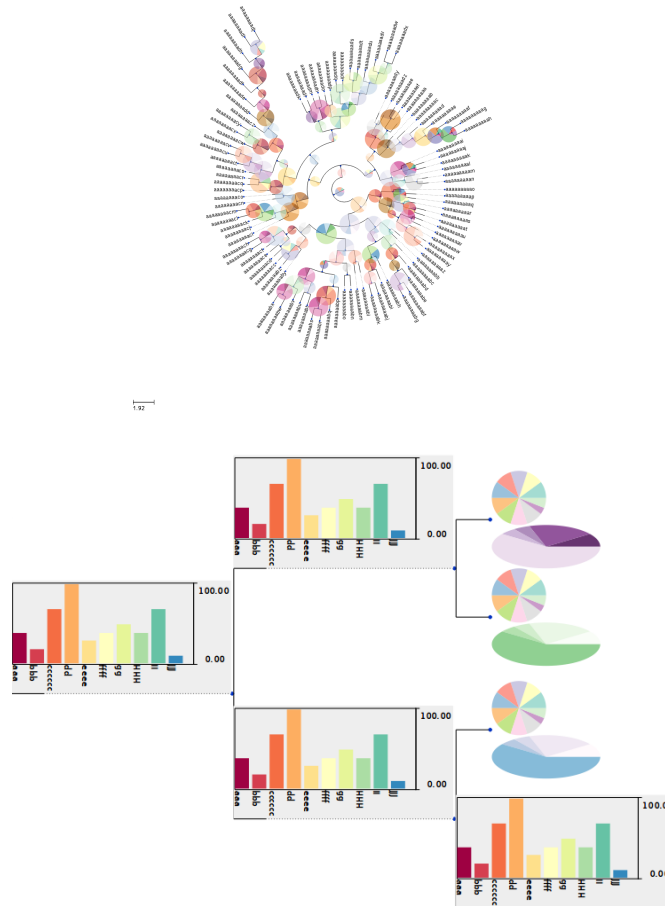

- **News on the GUI**

- Allows image region selection.
- Allows zooming on selected regions or specific nodes (Z - zoomIn, X - zoomOut, R - focus region).
- C-c will now interrupt the GUI application when started from a terminal.
- Added keyboard-based node navigation (click on a node and play the arrow keys).

1.3 What's new in ETE 2.1

- A basic standalone tree visualization program called “ete2” is now installed along with the package.
- The drawing engine has been completely rewritten to provide the following new features:
 - Added *TreeStyle* class allowing to set the following
 - * Added **circular tree drawing** mode
 - * Added tree *title face block* (Text or images that rendered on top of the tree)
 - * Added tree *legend face block* (Text or images that rendered as image legend)
 - * Added support for *tree rotation and orientation*

- * Possibility of drawing *aligned faces as a table*
- * Added header and footer regions for aligned faces.
- * And more! Check *TreeStyle* documentation
- Added new face positions **float**, **branch-top** and **branch-bottom**. See tutorial (*Node faces*) for more details.
- Added several *Face* attributes:
 - * face border
 - * face background color
 - * left, right, top and bottom margins
 - * face opacity
 - * horizontal and vertical alignment (useful when faces are rendered as table)
- Added support for predefined *NodeStyle*, which can be set outside the layout function (allows to save and export image rendering info)
- **Added new face types:**
 - * *CircleFace* (basic circle/sphere forms)
 - * *TreeFace* (trees within trees)
 - * *StaticItemFace* and *DynamicItemFace* (create custom and interactive Qt-GraphicsItems)
- **Improved faces:**
 - * *AttrFace* accepts prefix and suffix text, as well as a text formatter function. `fstyle` argument can be set to *italic*
 - * *TextFace*: `fstyle` argument can be set to *italic*
- **Save and export images**
 - * Added full support for SVG image rendering
 - * Added more options to the *TreeNode.render()* function to control image size and resolution
- Added support for *SVG_COLORS* names in faces and node styles
- **Core methods:**
 - Added *TreeNode.copy()*: returns an exact and independent copy of node and all its attributes
 - Added *TreeNode.convert_to_ultrametric()*: converts all branch lengths to allow leaves to be equidistant to root
 - Added *TreeNode.sort_descendants()*: sort tree branches according to node names.
 - Added *TreeNode.ladderize()*: sort tree branches according to partition size
 - Added *TreeNode.get_partitions()*: return the set of all possible partitions grouping leaf nodes

- Tree nodes can now be fully exported using cPickle
- Newick parser can read and export branch distances and support values using scientific notation
- `TreeNode.swap_childs()` method has changed to `TreeNode.swap_children()`
- Added `ete2.nexml` module (read and write nexml format)
- Added `ete2.phyloxml` module (read and write phyloxml format)
- Added `ete2.webplugin` module: Allows to create interactive web tree applications
- Tree visualization GUI checks now for newer version of the ETE package.
- Added `PhylomeDB3Connector`
- Added `PhyloNode.get_farthest_oldest_node()` function, which allows to find the best outgroup node in a tree, even if it is an internal node.
- **Bug Fixes and improvements:**
 - Fix: `TreeNode.get_common_ancestor()` accepts a single argument (node or list of nodes) instead of a succession or nodes. It can also return the path of each node to the parent.
 - Fix: Fast scroll based zoom-in was producing tree image inversions
 - Fix: Phylip parser does not truncate long names by default
 - Fix: “if not node” syntax was using a `len(node)` test, which made it totally inefficient. Now, the same expression returns always `True`
 - Improvement: Traversing methods are now much faster (specially preorder and level-order)
 - Improvement: Faster populate function (added possibility of random and non-random branch lengths)
 - Improvement: Faster prune function
 - Improvement: unicode support for tree files
 - Improvement: Added newick support for scientific notation in branch lengths
- **Improved documentation and examples:**
 - Online and PDF tutorial
 - Better library reference
 - A set of examples is now provided with the installation package and [here](#)

The ETE tutorial

Contents:

2.1 Working With Tree Data Structures

Contents

- *Working With Tree Data Structures*
 - *Trees*
 - *Reading and Writing Newick Trees*
 - * *Reading newick trees*
 - * *Writing newick trees*
 - *Understanding ETE Trees*
 - *Basic tree attributes*
 - * *Root node on unrooted trees?*
 - *Browsing trees (traversing)*
 - * *Getting Leaves, Descendants and Node's Relatives*
 - * *Traversing (browsing) trees*
 - * *Advanced traversing (stopping criteria)*
 - *Collapsing nodes while traversing (custom is_leaf definition)*
 - * *Iterating instead of Getting*
 - * *Finding nodes by their attributes*
 - *Search_all nodes matching a given criteria*
 - *Search nodes matching a given criteria (iteration)*
 - *Find the first common ancestor*
 - *Custom searching functions*
 - *Shortcuts*
 - *Checking the monophyly of attributes within a tree*
 - *Caching tree content for faster lookup operations*
 - *Node annotation*
 - *Comparing Trees*
 - * *Calculate distances between trees*
 - * *Robinson-foulds distance*
 - *Modifying Tree Topology*
 - * *Creating Trees from Scratch*
 - * *Deleting (eliminating) and Removing (detaching) nodes*
 - *Pruning trees*
 - *Concatenating trees*
 - *Copying (duplicating) trees*
 - *Solving multifurcations*
 - *Tree Rooting*
 - *Working with branch distances*
 - * *Getting distances between nodes*
 - * *getting midpoint outgroup*

2.1.1 Trees

Trees are a widely-used type of data structure that emulates a tree design with a set of linked nodes. Formally, a tree is considered an acyclic and connected graph. Each node in a tree has zero or more child nodes, which are below it in the tree (by convention, trees grow down, not up as they do in nature). A node that has a child is called the child's parent node (or ancestor node, or superior). A node has at most one parent.

The height of a node is the length of the longest downward path to a leaf from that node. The height of the root is the height of the tree. The depth of a node is the length of the path to its root (i.e., its root path).

- The topmost node in a tree is called the root node. Being the topmost node, the root node will not have parents. It is the node at which operations on the tree commonly begin (although some algorithms begin with the leaf nodes and work up ending at the root). All other nodes can be reached from it by following edges or links. Every node in a tree can be seen as the root node of the subtree rooted at that node.
- Nodes at the bottommost level of the tree are called leaf nodes. Since they are at the bottommost level, they do not have any children.
- An internal node or inner node is any node of a tree that has child nodes and is thus not a leaf node.
- A subtree is a portion of a tree data structure that can be viewed as a complete tree in itself. Any node in a tree T, together with all the nodes below it, comprise a subtree of T. The subtree corresponding to the root node is the entire tree; the subtree corresponding to any other node is called a proper subtree (in analogy to the term proper subset).

In bioinformatics, trees are the result of many analyses, such as phylogenetics or clustering. Although each case entails specific considerations, many properties remains constant among them. In this respect, ETE is a python toolkit that assists in the automated manipulation, analysis and visualization of any type of hierarchical trees. It provides general methods to handle and visualize tree topologies, as well as specific modules to deal with phylogenetic and clustering trees.

2.1.2 Reading and Writing Newick Trees

The Newick format is one of the most widely used standard representation of trees in bioinformatics. It uses nested parentheses to represent hierarchical data structures as text strings. The original newick standard is able to encode information about the tree topology, branch distances and node names. Nevertheless, it is not uncommon to find slightly different formats using the newick standard.

ETE can read and write many of them:

FOR-MAT	DESCRIPTION	SAMPLE
0	flexible with support values	((D:0.723274,F:0.567784)1.000000:0.067192,(B:0.279326,H:0.756049)1.000000:0.067192);
1	flexible with internal node names	((D:0.723274,F:0.567784)E:0.067192,(B:0.279326,H:0.756049)B:0.807788);
2	all branches + leaf names + internal supports	((D:0.723274,F:0.567784)1.000000:0.067192,(B:0.279326,H:0.756049)1.000000:0.067192);
3	all branches + all names	((D:0.723274,F:0.567784)E:0.067192,(B:0.279326,H:0.756049)B:0.807788);
4	leaf branches + leaf names	((D:0.723274,F:0.567784),(B:0.279326,H:0.756049));
5	internal and leaf branches + leaf names	((D:0.723274,F:0.567784):0.067192,(B:0.279326,H:0.756049):0.807788);
6	internal branches + leaf names	((D,F):0.067192,(B,H):0.807788);
7	leaf branches + all names	((D:0.723274,F:0.567784)E,(B:0.279326,H:0.756049)B);
8	all names	((D,F)E,(B,H)B);
9	leaf names	((D,F),(B,H));
100	topology only	((,),(,));

Formats labeled as *flexible* allow for missing information. For instance, format 0 will be able to load a newick tree even if it does not contain branch support information (it will be initialized with the default value). However, format 2 would raise an exception. In other words, if you want to control that your newick files strictly follow a given pattern you should use **strict** format definitions.

Reading newick trees

In order to load a tree from a newick text string you can use the constructor `TreeNode` or its `Tree` alias, provided by the main module `ete2`. You will only need to pass a text string containing the newick structure and the format that should be used to parse it (0 by default). Alternatively, you can pass the path to a text file containing the newick string.

```
from ete2 import Tree

# Loads a tree structure from a newick string. The returned variable 't' is the root node
t = Tree("(A:1,(B:1,(E:1,D:1):0.5):0.5);" )

# Load a tree structure from a newick file.
t = Tree("genes_tree.nh")

# You can also specify the newick format. For instance, for named internal nodes we will
t = Tree("(A:1,(B:1,(E:1,D:1)Internal_1:0.5)Internal_2:0.5)Root;", format=1)
```

Writing newick trees

Any ETE tree instance can be exported using newick notation using the `Tree.write()` method, which is available in any tree node instance. It also allows for format selection (*Reading and Writing Newick Trees*), so you can use the same function to convert between newick formats.

```
from ete2 import Tree

# Loads a tree with internal node names
t = Tree("(A:1,(B:1,(E:1,D:1)Internal_1:0.5)Internal_2:0.5)Root;", format=1)

# And prints its newick using the default format

print t.write() # (A:1.000000,(B:1.000000,(E:1.000000,D:1.000000)1.000000:0.500000)1.000000:0.500000)1.000000:0.500000

# To print the internal node names you need to change the format:

print t.write(format=1) # (A:1.000000,(B:1.000000,(E:1.000000,D:1.000000)Internal_1:0.500000)Internal_2:0.500000)Root;

# We can also write into a file
t.write(format=1, outfile="new_tree.nw")
```

2.1.3 Understanding ETE Trees

Any tree topology can be represented as a succession of **nodes** connected in a hierarchical way. Thus, for practical reasons, ETE makes no distinction between tree and node concepts, as any tree can be represented by its root node. This allows to use any internal node within a tree as another sub-tree instance.

Once trees are loaded, they can be manipulated as normal python objects. Given that a tree is actually a collection of nodes connected in a hierarchical way, what you usually see as a tree will be the root node instance from which the tree structure is hanging. However, every node within a ETE's tree structure can be also considered a subtree. This means, for example, that all the operational methods that we will review in the following sections are available at any possible level within a tree. Moreover, this feature will allow you to separate large trees into smaller partitions, or concatenate several trees into a single structure. For this reason, you will find that the `TreeNode` and `Tree` classes are synonymous.

2.1.4 Basic tree attributes

Each tree node has two basic attributes used to establish its position in the tree: `TreeNode.up` and `TreeNode.children`. The first is a pointer to parent's node, while the later is a list of children nodes. Although it is possible to modify the structure of a tree by changing these attributes, it is strongly recommend not to do it. Several methods are provided to manipulate each node's connections in a safe way (see *Comparing Trees*).

In addition, three other basic attributes are always present in any tree node instance:

Method	Description	Default value
<code>TreeNode.dist</code>	stores the distance from the node to its parent (branch length). Default value = 1.0	1.0
<code>TreeNode.support</code>	informs about the reliability of the partition defined by the node (i.e. bootstrap support)	1.0
<code>TreeNode.name</code>	Custom node's name.	NoName

In addition, several methods are provided to perform basic operations on tree node instances:

Method	Description
<code>TreeNode.is_leaf()</code>	returns True if <i>node</i> has no children
<code>TreeNode.is_root()</code>	returns True if <i>node</i> has no parent
<code>TreeNode.get_tree_root()</code>	returns the top-most node within the same tree structure as <i>node</i>
<code>len(TreeNode)</code>	returns the number of leaves under <i>node</i>
<code>print node</code>	prints a text-based representation of the tree topology under <i>node</i>
<code>if node in tree</code>	returns true if <i>node</i> is a leaf under <i>tree</i>
<code>for leaf in node</code>	iterates over all leaves under <i>node</i>
<code>TreeNode.show()</code>	Explore node graphically using a GUI.

This is an example on how to access such attributes:

```

from ete2 import Tree
t = Tree()
# We create a random tree topology
t.populate(15)
print t
print t.children
print t.get_children()
print t.up
print t.name
print t.dist
print t.is_leaf()
print t.get_tree_root()
print t.children[0].get_tree_root()
print t.children[0].children[0].get_tree_root()
# You can also iterate over tree leaves using a simple syntax
for leaf in t:
    print leaf.name
    
```

Root node on unrooted trees?

When a tree is loaded from external sources, a pointer to the top-most node is returned. This is called the tree root, and **it will exist even if the tree is conceptually considered as unrooted**. This is, the root node can be considered as the master node, since it represents the whole tree structure. Unrooted trees can be identified as trees in which master root node has more than two children.

```
from ete2 import Tree
unrooted_tree = Tree( "(A,B,(C,D));" )
print unrooted_tree
#
#      /-A
#      |
#-----|---B
#      |
#      |      /-C
#      \----|
#              \-D

rooted_tree = Tree( "((A,B).(C,D));" )
print rooted_tree
#
#              /-A
#      /-----|
#      |              \-B
#-----|
#      |              /-C
#      \----|
#              \-D
```

2.1.5 Browsing trees (traversing)

One of the most basic operations for tree analysis is *tree browsing*. This is, essentially, visiting nodes within a tree. ETE provides a number of methods to search for specific nodes or to navigate over the hierarchical structure of a tree.

Getting Leaves, Descendants and Node's Relatives

TreeNode instances contain several functions to access their descendants. Available methods are self explanatory:

Traversing (browsing) trees

Often, when processing trees, all nodes need to be visited. This is called tree traversing. There are different ways to traverse a tree structure depending on the order in which children nodes are visited. ETE implements the three most common strategies: **preorder**, **levelorder** and **postorder**. The following scheme shows the differences in the strategy for visiting nodes (note that in both cases the whole tree is browsed):

- preorder: 1) Visit the root, 2) Traverse the left subtree, 3) Traverse the right subtree.
- postorder: 1) Traverse the left subtree, 2) Traverse the right subtree, 3) Visit the root

- levelorder (default): every node on a level before is visited going to a lower level

Note:

- Preorder traversal sequence: F, B, A, D, C, E, G, I, H (root, left, right)
 - Inorder traversal sequence: A, B, C, D, E, F, G, H, I (left, root, right); note how this produces a sorted sequence
 - Postorder traversal sequence: A, C, E, D, B, H, I, G, F (left, right, root)
 - Level-order traversal sequence: F, B, G, A, D, I, C, E, H
-

Every node in a tree includes a `TreeNode.traverse()` method, which can be used to visit, one by one, every node node under the current partition. In addition, the `TreeNode.iter_descendants()` method can be set to use either a post- or a preorder strategy. The only different between `TreeNode.traverse()` and `TreeNode.iter_descendants()` is that the first will include the root node in the iteration.

strategy can take one of the following values: "postorder", "preorder" or "levelorder"

```
# we load a tree
t = Tree('(((H,K)D,(F,I)G)B,E)A,((L,(N,Q)O)J,(P,S)M)C);', format=1)

for node in t.traverse("postorder"):
    # Do some analysis on node
    print node.name

# If we want to iterate over a tree excluding the root node, we can
# use the iter_descendant method
for node in t.iter_descendants("postorder"):
    # Do some analysis on node
    print node.name
```

Additionally, you can implement your own traversing function using the structural attributes of nodes. In the following example, only nodes between a given leaf and the tree root are visited.

```
from ete2 import Tree
tree = Tree( "(A:1,(B:1,(C:1,D:1):0.5):0.5);" )

# Browse the tree from a specific leaf to the root
node = t.search_nodes(name="C")[0]
while node:
    print node
    node = node.up
```

Advanced traversing (stopping criteria)

Collapsing nodes while traversing (custom `is_leaf` definition)

From version 2.2, ETE supports the use of the `is_leaf_fn` argument in most of its traversing functions. The value of `is_leaf_fn` is expected to be a pointer to any python function that accepts a node instance as its first argument and returns a boolean value (True if node should be considered a leaf node).

By doing so, all traversing methods will use such a custom function to decide if a node is a leaf. This becomes specially useful when dynamic collapsing of nodes is needed, thus avoiding to prune the same tree in many different ways.

For instance, given a large tree structure, the following code will export the newick of the pruned version of the topology, where nodes grouping the same tip labels are collapsed.

```
from ete2 import Tree
def collapsed_leaf(node):
    if len(node2labels[node]) == 1:
        return True
    else:
        return False

t = Tree("(((a,a,a)a,a)aa, (b,b)b)ab, (c, (d,d)d)cd);", format=1)
print t
# We create a cache with every node content
node2labels = t.get_cached_content(store_attr="name")
print t.write(is_leaf_fn=collapsed_leaf)
#           /-a
#           |
#           /-|--a
#           | |
#           /-| \-a
#           | |
#           /-| \-a
#           | | /-b
#           --| \-|
#           | \-b
#           |
#           | /-c
#           \-|
#           | /-d
#           \-|
#           \-d

# We can even load the collapsed version as a new tree
t2 = Tree( t.write(is_leaf_fn=collapsed_leaf) )
print t2
#           /-aa
#           /-|
#           | \-b
#           --|
#           | /-c
#           \-|
#           \-d
```

Another interesting use of this approach is to find the first matching nodes in a given tree that match a custom set of criteria, without browsing the whole tree structure.

Let's say we want get all deepest nodes in a tree whose branch length is larger than one:

```
from ete2 import Tree
t = Tree("(((a,b)ab:2, (c, d)cd:2)abcd:2, ((e, f):2, g)efg:2);", format=1)
def processable_node(node):
    if node.dist > 1:
        return True
```



```

else:
    return False

for leaf in t.iter_leaves(is_leaf_fn=processable_node):
    print leaf

#      /-a
#     /-|
#    /  \-b
#  --|
#   /  /-c
#  \-|
#   \-d
#
#      /-e
#     /-|
#    --|  \-f
#     /
#    \-g
    
```

Iterating instead of Getting

As commented previously, methods starting with **get_** are all prepared to return results as a closed list of items. This means, for instance, that if you want to process all tree leaves and you ask for them using the *TreeNode.get_leaves()* method, the whole tree structure will be browsed before returning the final list of terminal nodes. This is not a problem in most of the cases, but in large trees, you can speed up the browsing process by using iterators.

Most **get_** methods have their homologous iterator functions. Thus, *TreeNode.get_leaves()* could be substituted by *TreeNode.iter_leaves()*. The same occurs with *TreeNode.iter_descendants()* and *TreeNode.iter_search_nodes()*.

When iterators are used (note that is only applicable for looping), only one step is processed at a time. For instance, *TreeNode.iter_search_nodes()* will return one match in each iteration. In practice, this makes no differences in the final result, but it may increase the performance of loop functions (i.e. in case of finding a match which interrupts the loop).

Finding nodes by their attributes

Both terminal and internal nodes can be located by searching along the tree structure. Several methods are available:

method	Description
<i>t.search_nodes(attr=value)</i>	Returns a list of nodes in which attr is equal to value, i.e. name=A
<i>t.iter_search_nodes(attr=value)</i>	Iterates over all matching nodes matching attr=value. Faster when you only need to get the first occurrence
<i>t.get_leaves_by_name(name)</i>	Returns a list of leaf nodes matching a given name. Only leaves are browsed.
<i>t.get_common_ancestor([node1, node2, node3])</i>	Return the first internal node grouping node1, node2 and node3
<i>t&"A"</i>	Shortcut for <i>t.search_nodes(name="A")[0]</i>

Search_all nodes matching a given criteria

A custom list of nodes matching a given name can be easily obtain through the `TreeNode.search_node()` function.

```
from ete2 import Tree
t = Tree( '((H:1,I:1):0.5, A:1, (B:1,(C:1,D:1):0.5):0.5);' )
print t
#
#           /-H
#        /-----|
#       /         \-I
#      /
#-----|---A
#      |
#      |         /-B
#      |        \-----|
#      |           |         /-C
#      |           |        \-----|
#      |           |         \-D
#
# I get D
D = t.search_nodes(name="D") [0]

# I get all nodes with distance=0.5
nodes = t.search_nodes(dist=0.5)
print len(nodes), "nodes have distance=0.5"

# We can limit the search to leaves and node names (faster method).
D = t.get_leaves_by_name(name="D")
print D
```

Search nodes matching a given criteria (iteration)

A limitation of the `TreeNode.search_nodes()` method is that you cannot use complex conditional statements to find specific nodes. When search criteria is too complex, you may need to create your own search function.

```
from ete2 import Tree

def search_by_size(node, size):
    "Finds nodes with a given number of leaves"
    matches = []
    for n in node.traverse():
        if len(n) == size:
            matches.append(n)
    return matches

t = Tree()
t.populate(40)
# returns nodes containing 6 leaves
search_by_size(t, size=6)
```

Find the first common ancestor

Searching for the first common ancestor of a given set of nodes it is a handy way of finding internal nodes.

```
from ete2 import Tree
t = Tree( "(H:0.3,I:0.1):0.5, A:1, (B:0.4,(C:0.5,(J:1.3,(F:1.2,D:0.1):0.5):0.5):0.5);")
print t
ancestor = t.get_common_ancestor("C", "J", "B")
```

Custom searching functions

A limitation of the previous methods is that you cannot use complex conditional statements to find specific nodes. However you can use traversing methods to meet your custom filters. A possible general strategy would look like this:

```
from ete2 import Tree
t = Tree("((H:0.3,I:0.1):0.5, A:1, (B:0.4,(C:1,D:1):0.5):0.5);")
# Create a small function to filter your nodes
def conditional_function(node):
    if node.dist > 0.3:
        return True
    else:
        return False

# Use previous function to find matches. Note that we use the traverse
# method in the filter function. This will iterate over all nodes to
# assess if they meet our custom conditions and will return a list of
# matches.
matches = filter(conditional_function, t.traverse())
print len(matches), "nodes have distance >0.3"

# depending on the complexity of your conditions you can do the same
# in just one line with the help of lambda functions:
matches = filter(lambda n: n.dist>0.3 and n.is_leaf(), t.traverse() )
print len(matches), "nodes have distance >0.3 and are leaves"
```

Shortcuts

Finally, ETE implements a built-in method to find the first node matching a given name, which is one of the most common tasks needed for tree analysis. This can be done through the operator & (AND). Thus, `TreeNode&"A"` will always return the first node whose name is "A" and that is under the tree "MyTree". The syntax may seem confusing, but it can be very useful in some situations.

```
from ete2 import Tree
t = Tree("((H:0.3,I:0.1):0.5, A:1, (B:0.4,(C:1,(J:1,(F:1,D:1):0.5):0.5):0.5):0.5);")
# Get the node D in a very simple way
D = t&"D"
# Get the path from B to the root
node = D
path = []
while node.up:
    path.append(node)
    node = node.up
```

```

print t
# I subtract D node from the total number of visited nodes
print "There are", len(path)-1, "nodes between D and the root"
# Using parentheses you can use by-operand search syntax as a node
# instance itself
Dsparent= (t&"C").up
Bsparent= (t&"B").up
Jsparent= (t&"J").up
# I check if nodes belong to certain partitions
print "It is", Dsparent in Bsparent, "that C's parent is under B's ancestor"
print "It is", Dsparent in Jsparent, "that C's parent is under J's ancestor"

```

2.1.6 Checking the monophyly of attributes within a tree

Although monophyly is actually a phylogenetic concept used to refer to a set of species that group exclusively together within a tree partition, the idea can be easily exported to any type of trees.

Therefore, we could consider that a set of values for a given node attribute present in our tree is monophyletic, if such values group exclusively together as a single tree partition. If not, the corresponding relationship connecting such values (para or poly-phyletic) could be also be inferred.

The `TreeNode.check_monophyly()` method will do so when a given tree is queried for any custom attribute.

```

from ete2 import Tree
t = Tree("((((((a, e), i), o),h), u), ((f, g), j));")
print t

#           /-a
#           /-l
#           /-l  \-e
#           |  |
#           /-l  \-i
#           |  |
#           /-l  \-o
#           |  |
#           /-l  \-h
#           |  |
#           |  \-u
# --|
#   |           /-f
#   |           /-l
#   \-l         \-g
#           |
#           \-j

# We can check how, indeed, all vowels are not monophyletic in the
# previous tree, but polyphyletic (a foreign label breaks its monophyly)
print t.check_monophyly(values=["a", "e", "i", "o", "u"], target_attr="name")

# however, the following set of vowels are monophyletic
print t.check_monophyly(values=["a", "e", "i", "o"], target_attr="name")

# A special case of polyphyly, called paraphyly, is also used to
# define certain type of grouping. See this wikipedia article for

```

```
# disambiguation: http://en.wikipedia.org/wiki/Paraphyly
print t.check_monophyly(values=["i", "o"], target_attr="name")
```

Finally, the `TreeNode.get_monophyletic()` method is also provided, which allows to return a list of nodes within a tree where a given set of attribute values are monophyletic. Note that, although a set of values are not monophyletic regarding the whole tree, several independent monophyletic partitions could be found within the same topology.

For instance, in the following example, all clusters within the same tree exclusively grouping a custom set of annotations are obtained.

```
from ete2 import Tree
t = Tree("((((((4, e), i), o), h), u), ((3, 4), (i, june))))");
# we annotate the tree using external data
colors = {"a": "red", "e": "green", "i": "yellow",
          "o": "black", "u": "purple", "4": "green",
          "3": "yellow", "1": "white", "5": "red",
          "june": "yellow"}
for leaf in t:
    leaf.add_features(color=colors.get(leaf.name, "none"))
print t.get_ascii(attributes=["name", "color"], show_internal=False)

#
#           /-4, green
#           /-|
#          /-|  \-e, green
#         |  |
#        /-|  \-i, yellow
#       |  |
#      /-|  \-o, black
#     |  |
#    /-|  \-h, none
#   |  |
#  /-|  \-u, purple
# --|
#  |      /-3, yellow
#  |      /-|
#  |  |  \-4, green
#  |  \-|
#  |   | /-i, yellow
#  |   \-|
#  |      \-june, yellow

print "Green-yellow clusters:"
# And obtain clusters exclusively green and yellow
for node in t.get_monophyletic(values=["green", "yellow"], target_attr="color"):
    print node.get_ascii(attributes=["color", "name"], show_internal=False)

# Green-yellow clusters:
#
#       /-green, 4
#      /-|
#     --|  \-green, e
#      |
#     \-yellow, i
#
#       /-yellow, 3
#      /-|
```

```
# | \-green, 4  
# --|  
# | /-yellow, i  
# | \-|  
# | \-yellow, june
```

Note: When the target attribute is set to the “species” feature name, associated to any *PhyloTree* node, this method will accomplish with the standard phylogenetic definition of monophyly, polyphyly and parphyly.

2.1.7 Caching tree content for faster lookup operations

If your program needs to access to the content of different nodes very frequently, traversing the tree to get the leaves of each node over and over will produce significant slowdowns in your algorithm. From version 2.2 ETE provides a convenient methods to cache frequent data.

The method *TreeNode.get_cached_content()* returns a dictionary in which keys are node instances and values represent the content of such nodes. By default, content is understood as a list of leaf nodes, so looking up size or tip names under a given node will be instant. However, specific attributes can be cached by setting a custom `store_attr` value.

```
from ete2 import Tree  
t = Tree()  
t.populate(50)  
  
node2leaves = t.get_cached_content()  
  
# lets now print the size of each node without the need of  
# recursively traverse  
for n in t.traverse():  
    print "node %s contains %s tips" %(n.name, len(node2leaves[n]))
```

2.1.8 Node annotation

Every node contains three basic attributes: name (*TreeNode.name*), branch length (*TreeNode.dist*) and branch support (*TreeNode.support*). These three values are encoded in the newick format. However, any extra data could be linked to trees. This is called tree annotation.

The *TreeNode.add_feature()* and *TreeNode.add_features()* methods allow to add extra attributes (features) to any node. The first allows to add one one feature at a time, while the second can be used to add many features with the same call.

Once extra features are added, you can access their values at any time during the analysis of a tree. To do so, you only need to access to the *TreeNode.feature_name* attributes.

Similarly, *TreeNode.del_feature()* can be used to delete an attribute.

```
import random  
from ete2 import Tree  
# Creates a tree  
t = Tree( '( (H:0.3,I:0.1):0.5, A:1, (B:0.4,(C:0.5,(J:1.3,(F:1.2,D:0.1):0.5):0.5):0.5):0.5):0.5)'
```

```

# Let's locate some nodes using the get common ancestor method
ancestor=t.get_common_ancestor("J", "F", "C")
# the search_nodes method (I take only the first match )
A = t.search_nodes(name="A")[0]
# and using the shortcut to finding nodes by name
C= t&"C"
H= t&"H"
I= t&"I"

# Let's now add some custom features to our nodes. add_features can be
# used to add many features at the same time.
C.add_features(vowel=False, confidence=1.0)
A.add_features(vowel=True, confidence=0.5)
ancestor.add_features(nodetype="internal")

# Or, using the oneliner notation
(t&"H").add_features(vowel=False, confidence=0.2)

# But we can automatize this. (note that i will overwrite the previous
# values)
for leaf in t.traverse():
    if leaf.name in "AEIOU":
        leaf.add_features(vowel=True, confidence=random.random())
    else:
        leaf.add_features(vowel=False, confidence=random.random())

# Now we use these information to analyze the tree.
print "This tree has", len(t.search_nodes(vowel=True)), "vowel nodes"
print "Which are", [leaf.name for leaf in t.iter_leaves() if leaf.vowel==True]

# But features may refer to any kind of data, not only simple
# values. For example, we can calculate some values and store them
# within nodes.
#
# Let's detect leaf nodes under "ancestor" with distance higher than
# 1. Note that I'm traversing a subtree which starts from "ancestor"
matches = [leaf for leaf in ancestor.traverse() if leaf.dist>1.0]

# And save this pre-computed information into the ancestor node
ancestor.add_feature("long_branch_nodes", matches)

# Prints the precomputed nodes
print "These are nodes under ancestor with long branches", \
      [n.name for n in ancestor.long_branch_nodes]

# We can also use the add_feature() method to dynamically add new features.
label = raw_input("custom label:")
value = raw_input("custom label value:")
ancestor.add_feature(label, value)
print "Ancestor has now the [" + label + "] attribute with value [" + value + "]"

```

Unfortunately, newick format does not support adding extra features to a tree. Because of this drawback, several improved formats haven been (or are being) developed to read and write tree based information. Some of these new formats are based in a completely new standard (Phylogenetic XML standards), while others are extensions of the original newick format (NHX <http://phylosoft.org/NHX/http://phylosoft.org/NHX/>).

Currently, ETE includes support for the New Hampshire eXtended format (NHX), which uses the original newick standard and adds the possibility of saving additional data related to each tree node. Here is an example of an extended newick representation in which extra information is added to an internal node:

```
(A:0.35, (B:0.72, (D:0.60, G:0.12):0.64 [&&NHX:conf=0.01:name=INTERNAL]):0.56);
```

As you can notice, extra node features in the NHX format are enclosed between brackets. ETE is able to read and write features using such format, however, the encoded information is expected to be exportable as plain text.

The NHX format is automatically detected when reading a newick file, and the detected node features are added using the `TreeNode.add_feature()` method. Consequently, you can access the information by using the normal ETE's feature notation: `node.feature_name`. Similarly, features added to a tree can be included within the normal newick representation using the NHX notation. For this, you can call the `TreeNode.write()` method using the `features` argument, which is expected to be a list with the features names that you want to include in the newick string. Note that all nodes containing the supplied features will be exposed into the newick string. Use an empty features list (`features=[]`) to include all node's data into the newick string.

```
import random
from ete2 import Tree
# Creates a normal tree
t = Tree('((H:0.3,I:0.1):0.5, A:1, (B:0.4, (C:0.5, (J:1.3, (F:1.2, D:0.1):0.5):0.5):0.5):0.5)')
print t
# Let's locate some nodes using the get common ancestor method
ancestor=t.get_common_ancestor("J", "F", "C")
# Let's label leaf nodes
for leaf in t.traverse():
    if leaf.name in "AEIOU":
        leaf.add_features(vowel=True, confidence=random.random())
    else:
        leaf.add_features(vowel=False, confidence=random.random())

# Let's detect leaf nodes under "ancestor" with distance higher than
# 1. Note that I'm traversing a subtree which starts from "ancestor"
matches = [leaf for leaf in ancestor.traverse() if leaf.dist>1.0]

# And save this pre-computed information into the ancestor node
ancestor.add_feature("long_branch_nodes", matches)
print
print "NHX notation including vowel and confidence attributes"
print
print t.write(features=["vowel", "confidence"])
print
print "NHX notation including all node's data"
print

# Note that when all features are requested, only those with values
# equal to text-strings or numbers are considered. "long_branch_nodes"
# is not included into the newick string.
print t.write(features=[])
print
print "basic newick formats are still available"
print
print t.write(format=9, features=["vowel"])
# You don't need to do anything special to read NHX notation. Just
# specify the newick format and the NHX tags will be automatically
```



```
# detected.
nw = """
(( (ADH2:0.1 [&&NHX:S=human:E=1.1.1.1], ADH1:0.11 [&&NHX:S=human:E=1.1.1.1])
:0.05 [&&NHX:S=Primates:E=1.1.1.1:D=Y:B=100], ADHY:0.1 [&&NHX:S=nematode:
E=1.1.1.1], ADHX:0.12 [&&NHX:S=insect:E=1.1.1.1]) :0.1 [&&NHX:S=Metazoa:
E=1.1.1.1:D=N], (ADH4:0.09 [&&NHX:S=yeast:E=1.1.1.1], ADH3:0.13 [&&NHX:S=yeast:
E=1.1.1.1], ADH2:0.12 [&&NHX:S=yeast:E=1.1.1.1], ADH1:0.11 [&&NHX:S=yeast:E=1.1.1.1]) :0.1
 [&&NHX:S=Fungi]) [&&NHX:E=1.1.1.1:D=N];
"""
# Loads the NHX example found at http://www.phylosoft.org/NHX/
t = Tree(nw)
# And access node's attributes.
for n in t.traverse():
    if hasattr(n, "S"):
        print n.name, n.S
```

2.1.9 Comparing Trees

Calculate distances between trees

The **:Tree:compare** function allows to calculate distances between two trees based on any node feature (i.e. name, species, other tags) using robinson-foulds and edge compatibility distances. It automatically handles differences in tree sizes, shared nodes and duplicated feature names.

- result["rf"] = robinson-foulds distance between the two trees. (average of robinson-foulds distances if target tree contained duplication and was split in several subtrees)
- result["max_rf"] = Maximum robinson-foulds distance expected for this comparison
- result["norm_rf"] = normalized robinson-foulds distance (from 0 to 1)
- result["effective_tree_size"] = the size of the compared trees, which are pruned to the common shared nodes.
- result["ref_edges_in_source"] = compatibility score of the target tree with respect to the source tree (how many edges in reference are found in the source)
- result["source_edges_in_ref"] = compatibility score of the source tree with respect to the reference tree (how many edges in source are found in the reference)
- result["source_subtrees"] = number of subtrees in the source tree (1 if do not contain duplications)
- result["common_edges"] = a set of common edges between source tree and reference
- result["source_edges"] = the set of edges found in the source tree
- result["ref_edges"] = the set of edges found in the reference tree
- result["treeko_dist"] = TreeKO speciation distance for comparisons including duplication nodes.

Robinson-foulds distance

Two tree topologies can be compared using ETE and the Robinson-Foulds (RF) metric. The method `TreeNode.robinson_foulds()` available for any ETE tree node allows to:

- compare two tree topologies by their name labels (default) or any other annotated feature in the tree.

- compare topologies of different size and content. When two trees contain a different set of labels, only shared leaves will be used.
- examine size and content of matching and missing partitions. Since the method return the list of partitions found in both trees, details about matching partitions can be obtained easily.

In the following example, several of above mentioned features are shown:

```
from ete2 import Tree
t1 = Tree('((a,b),c), ((e, f), g));')
t2 = Tree('((a,c),b), ((e, f), g));')
rf, max_rf, common_leaves, parts_t1, parts_t2 = t1.robinson_foulds(t2)
print t1, t2
print "RF distance is %s over a total of %s" %(rf, max_rf)
print "Partitions in tree2 that were not found in tree1:", parts_t1 - parts_t2
print "Partitions in tree1 that were not found in tree2:", parts_t2 - parts_t1

# We can also compare trees sharing only part of their labels

t1 = Tree('((a,b),c), ((e, f), g));')
t2 = Tree('((a,c),b), (g, H));')
rf, max_rf, common_leaves, parts_t1, parts_t2 = t1.robinson_foulds(t2)

print t1, t2
print "Same distance holds even for partially overlapping trees"
print "RF distance is %s over a total of %s" %(rf, max_rf)
print "Partitions in tree2 that were not found in tree1:", parts_t1 - parts_t2
print "Partitions in tree1 that were not found in tree2:", parts_t2 - parts_t1
```

2.1.10 Modifying Tree Topology

Creating Trees from Scratch

If no arguments are passed to the `TreeNode` class constructor, an empty tree node will be returned. Such an orphan node can be used to populate a tree from scratch. For this, the `TreeNode.up`, and `TreeNode.children` attributes should never be used (unless it is strictly necessary). Instead, several methods exist to manipulate the topology of a tree:

```
from ete2 import Tree
t = Tree() # Creates an empty tree
A = t.add_child(name="A") # Adds a new child to the current tree root
                        # and returns it
B = t.add_child(name="B") # Adds a second child to the current tree
                        # root and returns it
C = A.add_child(name="C") # Adds a new child to one of the branches
D = C.add_sister(name="D") # Adds a second child to same branch as
                        # before, but using a sister as the starting
                        # point
R = A.add_child(name="R") # Adds a third child to the
                        # branch. Multifurcations are supported
# Next, I add 6 random leaves to the R branch names_library is an
# optional argument. If no names are provided, they will be generated
# randomly.
R.populate(6, names_library=["r1","r2","r3","r4","r5","r6"])
```



```

#           /           /           \O-----/
#           \C-----/           \-Q
#
#           /
#           /-P
#           \M-----/
#           \-S
# Get pointers to specific nodes
G = t.search_nodes(name="G")[0]
J = t.search_nodes(name="J")[0]
C = t.search_nodes(name="C")[0]
# If we remove J from the tree, the whole partition under J node will
# be detached from the tree and it will be considered an independent
# tree. We can do the same thing using two approaches: J.detach() or
# C.remove_child(J)
removed_node = J.detach() # = C.remove_child(J)
# if we know print the original tree, we will see how J partition is
# no longer there.
print "Tree after REMOVING the node J"
print t.get_ascii(show_internal=True)
#
#                               /-H
#                               /D-----/
#                               /           \-K
#                               /B-----/
#                               /           /-F
#                               /A-----/           \G-----/
#                               /           \-I
#                               /           \-E
#-NoName--/
#
#                               /-P
#                               \C----- /M-----/
#                               \-S
# however, if we DELETE the node G, only G will be eliminated from the
# tree, and all its descendants will then hang from the next upper
# node.
G.delete()
print "Tree after DELETING the node G"
print t.get_ascii(show_internal=True)
#
#                               /-H
#                               /D-----/
#                               /           \-K
#                               /B-----/
#                               /           |--F
#                               /A-----/           \-I
#                               /           \-E
#-NoName--/
#
#                               /-P
#                               \C----- /M-----/
#                               \-S

```

2.1.11 Pruning trees

Pruning a tree means to obtain the topology that connects a certain group of items by removing the unnecessary edges. To facilitate this task, ETE implements the `TreeNode.prune()` method, which

2.1.13 Copying (duplicating) trees

ETE provides several strategies to clone tree structures. The method `TreeNode.copy()` can be used to produce a new independent tree object with the exact topology and features as the original. However, as trees may involve many intricate levels of branches and nested features, 4 different methods are available to create a tree copy:

- “newick”: Tree topology, node names, branch lengths and branch support values will be copied as represented in the newick string. This method is based on newick format serialization and works very fast even for large trees.
- “newick-extended”: Tree topology and all node features will be copied based on the extended newick format representation. Only node features will be copied, thus excluding other node attributes. As this method is also based on newick serialisation, features will be converted into text strings when making the copy. Performance will depend on the tree size and the number and type of features being copied.
- “cpickle”: This is the default method. The whole node structure and its content will be cloned based on the cPickle object serialization python approach. This method is slower, but recommended for full tree copying.
- “deepcopy”: The whole node structure and its content is copied based on the standard “copy” Python functionality. This is the slowest method, but it allows to copy very complex objects even when attributes point to lambda functions.

```

from ete2 import Tree
t = Tree("((A, B)Internal_1:0.7, (C, D)Internal_2:0.5)root:1.3;", format=1)
# we add a custom annotation to the node named A
(t & "A").add_features(label="custom Value")
# we add a complex feature to the A node, consisting of a list of lists
(t & "A").add_features(complex=[[0,1], [2,3], [1,11], [1,0]])
print t.get_ascii(attributes=["name", "dist", "label", "complex"])

#
#           /-A, 0.0, custom Value, [[0, 1], [2, 3], [1, 11], [1, 0]]
#         /Internal_1, 0.7
#        |                \-B, 0.0
# -root, 1.3
#        |                /-C, 0.0
#         \Internal_2, 0.5
#          \                \-D, 0.0

# Newick copy will loose custom node annotations, complex features,
# but not names and branch values

print t.copy("newick").get_ascii(attributes=["name", "dist", "label", "complex"])

#
#           /-A, 0.0
#         /Internal_1, 0.7
#        |                \-B, 0.0
# -NoName, 0.0
#        |                /-C, 0.0
#         \Internal_2, 0.5
#          \                \-D, 0.0

# Extended newick copy will transfer custom annotations as text
# strings, so complex features are lost.

```

```

print t.copy("newick-extended").get_ascii(attributes=["name", "dist", "label", "complex"])

#
#           /-A, 0.0, custom Value, __0_ 1__ _2_ 3__ _1_ 11__ _1_ 0_
#           /Internal_1, 0.7
#           |           \-B, 0.0
# -NoName, 0.0
#           |           /-C, 0.0
#           \Internal_2, 0.5
#           \-D, 0.0

# The default pickle method will produce a exact clone of the
# original tree, where features are duplicated keeping their
# python data type.

print t.copy().get_ascii(attributes=["name", "dist", "label", "complex"])
print "first element in complex feature:", (t & "A").complex[0]

#
#           /-A, 0.0, custom Value, [[0, 1], [2, 3], [1, 11], [1, 0]]
#           /Internal_1, 0.7
#           |           \-B, 0.0
# -root, 1.3
#           |           /-C, 0.0
#           \Internal_2, 0.5
#           \-D, 0.0
# first element in complex feature: [0, 1]

```

2.1.14 Solving multifurcations

When a tree contains a polytomy (a node with more than 2 children), the method `resolve_polytomy()` can be used to convert the node into a randomly bifurcated structure in which branch lengths are set to 0. This is really not a solution for the polytomy but it allows to export the tree as a strictly bifurcated newick structure, which is a requirement for some external software.

The method can be used on a very specific node while keeping the rest of the tree intact by disabling the recursive flag.

```

from ete2 import Tree
t = Tree("(( (a, b, c), (d, e, f, g)), (f, i, h));")
print t

#
#           /-a
#           |
#           /--|--b
#           |   |
#           |   \-c
#           /--|
#           |   |   /-d
#           |   |   | y
#           |   |   |--e
#           |   \--|
# ---|           |--f
#           |           |
#           |           \-g
#           |
#           |   /-f
#           |   |

```



```
#      \--/--i
#      |
#      \-h

polynode = t.get_common_ancestor("a", "b")
polynode.resolve_polytomy(recursive=False)
print t
```

```
#      /-b
#      /--|
#      /--| \-c
#      |   |
#      |   \-a
#      /--|
#      |   |   /-d
#      |   |   |
#      |   |   /--e
#      |   \--|
#  ---|       /--f
#      |       |
#      |       \-g
#      |
#      |   /-f
#      |   |
#      \--/--i
#      |
#      \-h
```

```
t.resolve_polytomy(recursive=True)
print t
```

```
#      /-b
#      /--|
#      /--| \-c
#      |   |
#      |   \-a
#      |
#      /--|           /-f
#      |   |           /--|
#      |   |           /--| \-g
#      |   |           |   |
#      |   \--|       \-e
#  ---|       |
#      |       \-d
#      |
#      |           /-i
#      |           /--|
#      \--|       \-h
#      |
#      \-f
```

2.1.15 Tree Rooting

Tree rooting is understood as the technique by which a given tree is conceptually polarized from more basal to more terminal nodes. In phylogenetics, for instance, this is a crucial step prior to the interpretation of trees, since it will determine the evolutionary relationships among the species involved. The concept of rooted trees is different than just having a root node, which is always necessary to handle a tree data structure. Usually, the way in which a tree is differentiated between rooted and unrooted, is by counting the number of branches of the current root node. Thus, if the root node has more than two child branches, the tree is considered unrooted. By contrast, when only two main branches exist under the root node, the tree is considered rooted.

Having an unrooted tree means that any internal branch within the tree could be regarded as the root node, and there is no conceptual reason to place the root node where it is placed at the moment. Therefore, in an unrooted tree, there is no information about which internal nodes are more basal than others. By setting the root node between a given edge/branch of the tree structure the tree is polarized, meaning that the two branches under the root node are the most basal nodes. In practice, this is usually done by setting an **outgroup node**, which would represent one of these main root branches. The second one will be, obviously, the brother node. When you set an outgroup on unrooted trees, the multifurcations at the current root node are solved.

In order to root an unrooted tree or re-root a tree structure, ETE implements the `TreeNode.set_outgroup()` method, which is present in any tree node instance. Similarly, the `TreeNode.unroot()` method can be used to perform the opposite action.

```

from ete2 import Tree
# Load an unrooted tree. Note that three branches hang from the root
# node. This usually means that no information is available about
# which of nodes is more basal.
t = Tree('(A, (H, F) (B, (E, D)))')
print "Unrooted tree"
print t
#
#      /-A
#      |
#      |      /-H
#-----|-----|
#      |      \-F
#      |
#      |      /-B
#      \-----|
#              |      /-E
#              \-----|
#                      \-D
#
# Let's define that the ancestor of E and D as the tree outgroup. Of
# course, the definition of an outgroup will depend on user criteria.
ancestor = t.get_common_ancestor("E", "D")
t.set_outgroup(ancestor)
print "Tree rooted at E and D's ancestor is more basal than the others."
print t
#
#              /-B
#              |
#      /-----|-----|      /-A
#      |      |      \-----|
#      |      |      |      /-H
#-----|-----|      \-----|

```

```

#           |                               \-F
#           |
#           |                               /-E
#           |-----|
#           |                               \-D
#
# Note that setting a different outgroup, a different interpretation
# of the tree is possible
t.set_outgroup( t&"A" )
print "Tree rooted at a terminal node"
print t
#
#                               /-H
#                               /-----|
#                               |       \-F
#                               |
#                               /-----|
#                               |       /-B
#                               |       \-----|
#-----|                       |       /-E
#                               |       \-----|
#                               |       \-D
#                               |
#                               \-A

```

Note that although **rooting** is usually regarded as a whole-tree operation, ETE allows to root subparts of the tree without affecting to its parent tree structure.

```

from ete2 import Tree
t = Tree('(((A,C),((H,F),(L,M))),((B,(J,K))(E,D)));')
print "Original tree:"
print t
#
#                               /-A
#                               /-----|
#                               |       \-C
#                               |
#                               /-----|
#                               |       /-H
#                               |       /-----|
#                               |       |       \-F
#                               |       |
#                               |       /-----|
#                               |       |       /-L
#                               |       |       \-----|
#-----|                       |       |       \-M
#                               |       |
#                               |       /-B
#                               |       /-----|
#                               |       |       /-J
#                               |       |       \-----|
#-----|                       |       |       \-K
#                               |       |
#                               |       /-E
#                               |       \-----|
#                               |       \-D
#
# Each main branch of the tree is independently rooted.
node1 = t.get_common_ancestor("A","H")
node2 = t.get_common_ancestor("B","D")
node1.set_outgroup("H")
node2.set_outgroup("E")

```



2.2 The Programmable Tree Drawing Engine

Contents

- *The Programmable Tree Drawing Engine*
 - *Overview*
 - *Interactive visualization of trees*
 - *Rendering trees as images*
 - *Customizing the aspect of trees*
 - * *Tree style*
 - *Show leaf node names, branch length and branch support*
 - *Change branch length scale (zoom in X)*
 - *Change branch separation between nodes (zoom in Y)*
 - *Rotate a tree*
 - *circular tree in 180 degrees*
 - *Add legend and title*
 - * *Node style*
 - * *Node faces*
 - *Faces position*
 - *Face properties*
 - * *layout functions*
 - *Combining styles, faces and layouts*
 - * *Fixed node styles*
 - * *Node backgrounds*
 - * *Img Faces*
 - * *Bubble tree maps*
 - * *Trees within trees*
 - * *Phylogenetic trees and sequence domains*
 - * *Creating your custom interactive Item faces*

2.2.1 Overview

ETE's treeview extension provides a highly programmable drawing system to render any hierarchical tree structure as PDF, SVG or PNG images. Although several predefined visualization layouts are included with the default installation, custom styles can be easily created from scratch.

Image customization is performed through four elements: **a)** *TreeStyle*, setting general options about the image (shape, rotation, etc.), **b)** *NodeStyle*, which defines the specific aspect of each node (size, color, background, line type, etc.), **c)** node *faces*.Face which are small pieces of extra graphical information that can be added to nodes (text labels, images, graphs, etc.) **d)** a *layout* function, a normal python function that controls how node styles and faces are dynamically added to nodes.

Images can be rendered as **PNG, PDF** or **SVG** files using the *TreeNode.render()* method or interactively visualized using a built-in Graphical User Interface (GUI) invoked by the *TreeNode.show()* method.

2.2.2 Interactive visualization of trees

ETE's tree drawing engine is fully integrated with a built-in graphical user interface (GUI). Thus, ETE allows to visualize trees using an interactive interface that allows to explore and manipulate node's properties and tree topology. To start the visualization of a node (tree or subtree), you can simply call the *TreeNode.show()* method.

One of the advantages of this on-line GUI visualization is that you can use it to interrupt a given program/analysis, explore the tree, manipulate them, and continuing with the execution thread. Note that **changes made using the GUI will be kept after quitting the GUI**. This feature is specially useful for using during python sessions, in which analyses are performed interactively.

The GUI allows many operations to be performed graphically, however it does not implement all the possibilities of the programming toolkit.

```
from ete2 import Tree
t = Tree( "(a,b),c);" )
t.show()
```

2.2.3 Rendering trees as images

Tree images can be directly written as image files. SVG, PDF and PNG formats are supported. Note that, while PNG images are raster images, PDF and SVG pictures are rendered as **vector graphics**, thus allowing its later modification and scaling.

To generate an image, the *TreeNode.render()* method should be used instead of *TreeNode.show()*. The only required argument is the file name, whose extension will determine the image format (.PDF, .SVG or .PNG). Several parameters regarding the image size and resolution can be adjusted:

Argument	Description
units	“ px ”: pixels, “ mm ”: millimeters, “ in ”: inches
h	height of the image in units.
w	weight of the image in units.
dpi	dots per inches.

Note: If *h* and *w* values are both provided, image size will be adjusted even if it requires to break the

original aspect ratio of the image. If only one value (h or w) is provided, the other will be estimated to maintain aspect ratio. If no sizing values are provided, image will be adjusted to A4 dimensions.

```
from ete2 import Tree
t = Tree( "(a,b),c);" )
t.render("mytree.png", w=183, units="mm")
```

2.2.4 Customizing the aspect of trees

Image customization is performed through four main elements:

Tree style

The *TreeStyle* class can be used to create a custom set of options that control the general aspect of the tree image. Tree styles can be passed to the *TreeNode.show()* and *TreeNode.render()* methods. For instance, *TreeStyle* allows to modify the scale used to render tree branches or choose between circular or rectangular tree drawing modes.

```
from ete2 import Tree, TreeStyle

t = Tree( "(a,b),c);" )
circular_style = TreeStyle()
circular_style.mode = "c" # draw tree in circular mode
circular_style.scale = 20
t.render("mytree.png", w=183, units="mm", tree_style=circular_style)
```

Warning: A number of parameters can be controlled through custom tree style objects, check *TreeStyle* documentation for a complete list of accepted values.

Some common uses include:

Show leaf node names, branch length and branch support

Change branch length scale (zoom in X)

Change branch separation between nodes (zoom in Y)

Rotate a tree

circular tree in 180 degrees

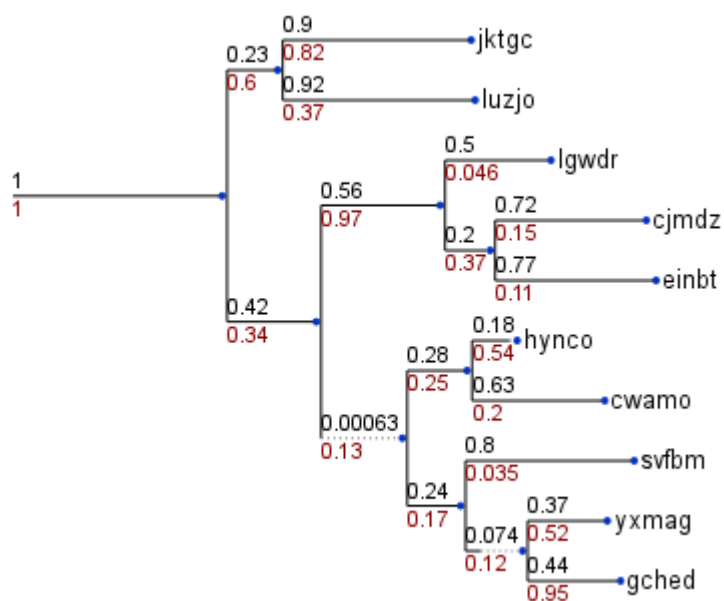

Fig. 2.1: Automatically adds node names and branch information to the tree image:

```

from ete2 import Tree, TreeStyle
t = Tree()
t.populate(10, random_dist=True)
ts = TreeStyle()
ts.show_leaf_name = True
ts.show_branch_length = True
ts.show_branch_support = True
t.show(tree_style=ts)

```

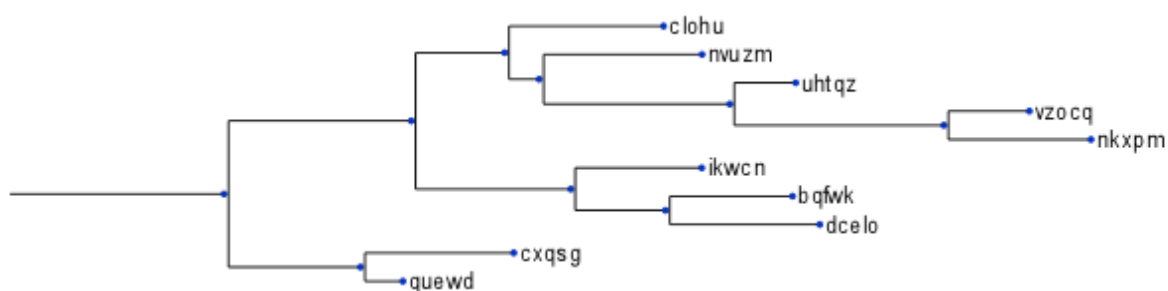

Fig. 2.2: Increases the length of the tree by changing the scale:

```

from ete2 import Tree, TreeStyle
t = Tree()
t.populate(10, random_dist=True)
ts = TreeStyle()
ts.show_leaf_name = True
ts.scale = 120 # 120 pixels per branch length unit
t.show(tree_style=ts)

```

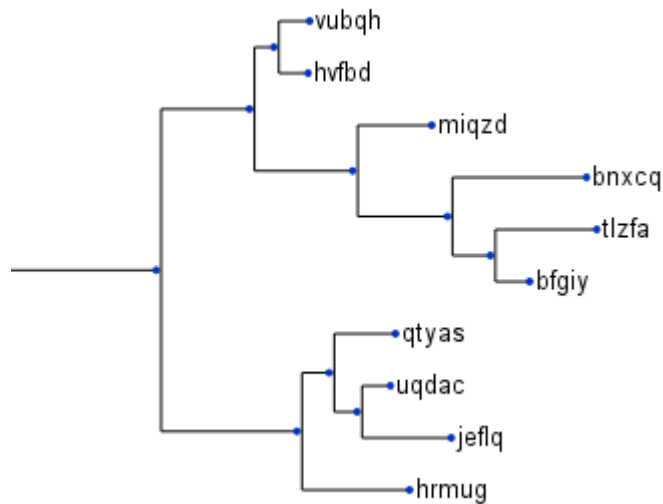

Fig. 2.3: Increases the separation between leaf branches:

```

from ete2 import Tree, TreeStyle
t = Tree()
t.populate(10, random_dist=True)
ts = TreeStyle()
ts.show_leaf_name = True
ts.branch_vertical_margin = 10 # 10 pixels between adjacent branches
t.show(tree_style=ts)

```

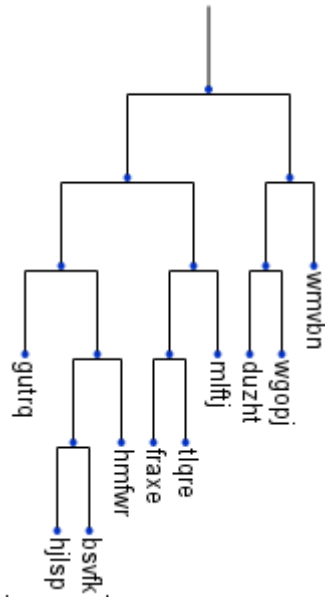

Fig. 2.4: Draws a rectangular tree from top to bottom:

```

from ete2 import Tree, TreeStyle
t = Tree()
t.populate(10)
ts = TreeStyle()
ts.show_leaf_name = True
ts.rotation = 90
t.show(tree_style=ts)

```

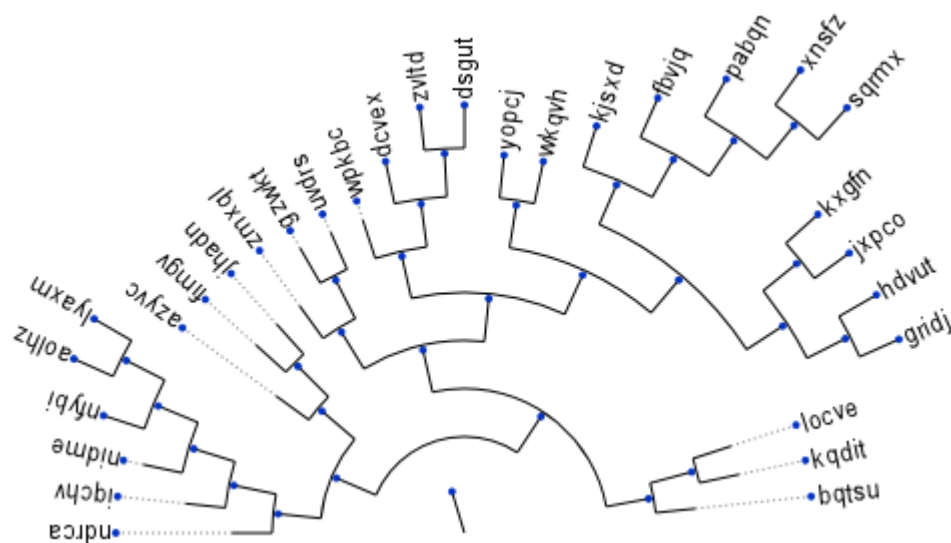

Fig. 2.5: Draws a circular tree using a semi-circumference:

```

from ete2 import Tree, TreeStyle
t = Tree()
t.populate(30)
ts = TreeStyle()
ts.show_leaf_name = True
ts.mode = "c"
ts.arc_start = -180 # 0 degrees = 3 o'clock
ts.arc_span = 180
t.show(tree_style=ts)
    
```

Add legend and title

```
from ete2 import Tree, TreeStyle, TextFace
t = Tree( "(a,b),c);" )
ts = TreeStyle()
ts.show_leaf_name = True
ts.title.add_face(TextFace("Hello ETE", fsize=20), column=0)
t.show(tree_style=ts)
```

Node style

Through the *NodeStyle* class the aspect of each single node can be controlled, including its size, color, background and branch type.

A node style can be defined statically and attached to several nodes:



Fig. 2.6: Simple tree in which the same style is applied to all nodes:

```
from ete2 import Tree, NodeStyle, TreeStyle
t = Tree( "(a,b),c);" )

# Basic tree style
ts = TreeStyle()
ts.show_leaf_name = True

# Draws nodes as small red spheres of diameter equal to 10 pixels
nstyle = NodeStyle()
nstyle["shape"] = "sphere"
nstyle["size"] = 10
nstyle["fgcolor"] = "darkred"

# Gray dashed branch lines
nstyle["hz_line_type"] = 1
nstyle["hz_line_color"] = "#cccccc"

# Applies the same static style to all nodes in the tree. Note that,
# if "nstyle" is modified, changes will affect to all nodes
for n in t.traverse():
    n.set_style(nstyle)

t.show(tree_style=ts)
```

If you want to draw nodes with different styles, an independent *NodeStyle* instance must be created for each node. Note that node styles can be modified at any moment by accessing the *TreeNode.img_style* attribute.

Static node styles, set through the `set_style()` method, will be attached to the nodes and exported as part of their information. For instance, *TreeNode.copy()* will replicate all node styles in the replicate tree. Note that node styles can be also modified on the fly through a `layout` function (see *layout functions*)

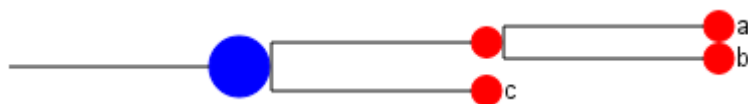

Fig. 2.7: Simple tree in which the different styles are applied to each node:

```
from ete2 import Tree, NodeStyle, TreeStyle
t = Tree( "(a,b),c);" )

# Basic tree style
ts = TreeStyle()
ts.show_leaf_name = True

# Creates an independent node style for each node, which is
# initialized with a red foreground color.
for n in t.traverse():
    nstyle = NodeStyle()
    nstyle["fgcolor"] = "red"
    nstyle["size"] = 15
    n.set_style(nstyle)

# Let's now modify the aspect of the root node
t.img_style["size"] = 30
t.img_style["fgcolor"] = "blue"

t.show(tree_style=ts)
```

Node faces

Node faces are small pieces of graphical information that can be linked to nodes. For instance, text labels or external images could be linked to nodes and they will be plotted within the tree image.

Several types of node faces are provided by the main `ete2` module, ranging from simple text (`TextFace`) and geometric shapes (`CircleFace`), to molecular sequence representations (`SequenceFace`), heatmaps and profile plots (`ProfileFace`). A complete list of available faces can be found at the [ete2.treeview](#) reference page..

Faces position

Faces can be added to different areas around the node, namely **branch-right**, **branch-top**, **branch-bottom** or **aligned**. Each area represents a table in which faces can be added through the `TreeNode.add_face()` method. For instance, if two text labels want to be drawn below the branch line of a given node, a pair of `TextFace` faces can be created and added to the columns 0 and 1 of the **branch-bottom** area:

```
from ete2 import Tree, TreeStyle, TextFace
t = Tree( "(a,b),c);" )

# Basic tree style
ts = TreeStyle()
ts.show_leaf_name = True

# Add two text faces to different columns
t.add_face(TextFace("hola "), column=0, position = "branch-right")
```

```
t.add_face(TextFace("mundo!"), column=1, position = "branch-right")
t.show(tree_style=ts)
```

If you add more than one face to the same area and column, they will be piled up. See the following image as an example of face positions:

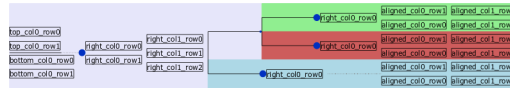

Fig. 2.8: Source code used to generate the above image.

Note: Once a face object is created, it can be linked to one or more nodes. For instance, the same text label can be recycled and added to several nodes.

Face properties

Apart from the specific config values of each face type, all face instances contain same basic attributes that permit to modify general aspects such as margins, background colors, border, etc. A complete list of face attributes can be found in the general `Face` class documentation. Here is a very simple example:

layout functions

Layout functions act as pre-drawing *hooking functions*. This means, when a node is about to be drawn, it is first sent to a layout function. Node properties, style and faces can be then modified on the fly and return it to the drawer engine. Thus, layout functions can be understood as a collection of rules controlling how different nodes should be drawn.

```
from ete2 import Tree
t = Tree( "(((a,b),c), d), e);" )

def abc_layout(node):
    vowels = set(["a", "e", "i", "o", "u"])
    if node.name in vowels:

        # Note that node style are already initialized with the
        # default values

        node.img_style["size"] = 15
        node.img_style["color"] = "red"

# Basic tree style
ts = TreeStyle()
ts.show_leaf_name = True

# Add two text faces to different columns
t.add_face(TextFace("hola "), column=0, position = "branch-right")
t.add_face(TextFace("mundo!"), column=1, position = "branch-right")
t.show(tree_style=ts)
```

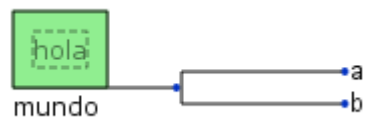

Fig. 2.9: Basic use of face general attributes

```
from ete2 import Tree, TreeStyle, TextFace

t = Tree( "(a,b);" )

# Basic tree style
ts = TreeStyle()
ts.show_leaf_name = True

# Creates two faces
hola = TextFace("hola")
mundo = TextFace("mundo")

# Set some attributes
hola.margin_top = 10
hola.margin_right = 10
hola.margin_left = 10
hola.margin_bottom = 10
hola.opacity = 0.5 # from 0 to 1
hola.inner_border.width = 1 # 1 pixel border
hola.inner_border.type = 1 # dashed line
hola.border.width = 1
hola.background.color = "LightGreen"

t.add_face(hola, column=0, position = "branch-top")
t.add_face(mundo, column=1, position = "branch-bottom")

t.show(tree_style=ts)
```

2.2.5 Combining styles, faces and layouts

Examples are probably the best way to show how ETE works:

Fixed node styles

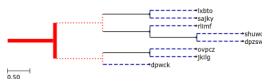

```

from ete2 import Tree, faces, AttrFace, TreeStyle, NodeStyle

def layout(node):
    # If node is a leaf, add the nodes name and a its scientific name
    if node.is_leaf():
        faces.add_face_to_node(AttrFace("name"), node, column=0)

def get_example_tree():

    t = Tree()
    t.populate(8)

    # Node style handling is no longer limited to layout functions. You
    # can now create fixed node styles and use them many times, save them
    # or even add them to nodes before drawing (this allows to save and
    # reproduce an tree image design)

    # Set bold red branch to the root node
    style = NodeStyle()
    style["fgcolor"] = "#0f0f0f"
    style["size"] = 0
    style["vt_line_color"] = "#ff0000"
    style["hz_line_color"] = "#ff0000"
    style["vt_line_width"] = 8
    style["hz_line_width"] = 8
    style["vt_line_type"] = 0 # 0 solid, 1 dashed, 2 dotted
    style["hz_line_type"] = 0
    t.set_style(style)

    #Set dotted red lines to the first two branches
    style1 = NodeStyle()
    style1["fgcolor"] = "#0f0f0f"
    style1["size"] = 0
    style1["vt_line_color"] = "#ff0000"
    style1["hz_line_color"] = "#ff0000"
    style1["vt_line_width"] = 2
    style1["hz_line_width"] = 2
    style1["vt_line_type"] = 2 # 0 solid, 1 dashed, 2 dotted
    style1["hz_line_type"] = 2
    t.children[0].img_style = style1
    t.children[1].img_style = style1

    # Set dashed blue lines in all leaves
    style2 = NodeStyle()
    style2["fgcolor"] = "#000000"
    style2["shape"] = "circle"

```

```

style2["vt_line_color"] = "#0000aa"
style2["hz_line_color"] = "#0000aa"
style2["vt_line_width"] = 2
style2["hz_line_width"] = 2
style2["vt_line_type"] = 1 # 0 solid, 1 dashed, 2 dotted
style2["hz_line_type"] = 1
for l in t.iter_leaves():
    l.img_style = style2

ts = TreeStyle()
ts.layout_fn = layout
ts.show_leaf_name = False

return t, ts

if __name__ == "__main__":
    t, ts = get_example_tree()
    t.show(tree_style=ts)
    #t.render("node_style.png", w=400, tree_style=ts)

```

Node backgrounds

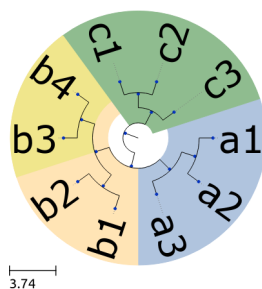

```

from ete2 import Tree, faces, AttrFace, TreeStyle, NodeStyle

def layout(node):
    if node.is_leaf():
        N = AttrFace("name", fsize=30)
        faces.add_face_to_node(N, node, 0, position="aligned")

def get_example_tree():
    # Set dashed blue lines in all leaves
    nst1 = NodeStyle()
    nst1["bgcolor"] = "LightSteelBlue"
    nst2 = NodeStyle()
    nst2["bgcolor"] = "Moccasin"
    nst3 = NodeStyle()
    nst3["bgcolor"] = "DarkSeaGreen"
    nst4 = NodeStyle()
    nst4["bgcolor"] = "Khaki"

    t = Tree("(((a1,a2),a3), ((b1,b2), (b3,b4))), ((c1,c2),c3));")
    for n in t.traverse():
        n.dist = 0

```

```

n1 = t.get_common_ancestor("a1", "a2", "a3")
n1.set_style(nst1)
n2 = t.get_common_ancestor("b1", "b2", "b3", "b4")
n2.set_style(nst2)
n3 = t.get_common_ancestor("c1", "c2", "c3")
n3.set_style(nst3)
n4 = t.get_common_ancestor("b3", "b4")
n4.set_style(nst4)
ts = TreeStyle()
ts.layout_fn = layout
ts.show_leaf_name = False

ts.mode = "c"
ts.root_opening_factor = 1
return t, ts

if __name__ == "__main__":
    t, ts = get_example_tree()
    #t.render("node_background.png", w=400, tree_style=ts)
    t.show(tree_style=ts)

```

Img Faces

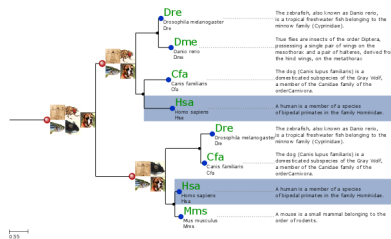

Note that images are attached to terminal and internal nodes.

```

# Import Tree instance and faces module
from ete2 import Tree, faces, TreeStyle

# Loads an example tree
nw = ""
(( (Dre:0.008339,Dme:0.300613)1.000000:0.596401,
  (Cfa:0.640858,Hsa:0.753230)1.000000:0.182035)1.000000:0.106234,
  ((Dre:0.271621,Cfa:0.046042)1.000000:0.953250,
  (Hsa:0.061813,Mms:0.110769)1.000000:0.204419)1.000000:0.973467);
""
t = Tree(nw)

# You can create any random tree containing the same leaf names, and
# layout will work equally
#
# t = Tree()
# Creates a random tree with 8 leaves using a given set of names
# t.populate(8, ["Dme", "Dre", "Hsa", "Ptr", "Cfa", "Mms"])

# Set the path in which images are located

```

```
img_path = "./"
# Create faces based on external images
humanFace = faces.ImgFace(img_path+"human.png")
mouseFace = faces.ImgFace(img_path+"mouse.png")
dogFace = faces.ImgFace(img_path+"dog.png")
chimpFace = faces.ImgFace(img_path+"chimp.png")
fishFace = faces.ImgFace(img_path+"fish.png")
flyFace = faces.ImgFace(img_path+"fly.png")

# Create a faces ready to read the name attribute of nodes
#nameFace = faces.TextFace(open("text").readline().strip(), fsize=20, fgcolor="#009000")
nameFace = faces.AttrFace("name", fsize=20, fgcolor="#009000")

# Create a conversion between leaf names and real names
code2name = {
    "Dre": "Drosophila melanogaster",
    "Dme": "Danio rerio",
    "Hsa": "Homo sapiens",
    "Ptr": "Pan troglodytes",
    "Mms": "Mus musculus",
    "Cfa": "Canis familiaris"
}

# Creates a dictionary with the descriptions of each leaf name
code2desc = {
    "Dre": """"The zebrafish, also known as Danio rerio,
is a tropical freshwater fish belonging to the
minnow family (Cyprinidae).""",
    "Dme": """"True flies are insects of the order Diptera,
possessing a single pair of wings on the
mesothorax and a pair of halteres, derived from
the hind wings, on the metathorax""",
    "Hsa": """"A human is a member of a species
of bipedal primates in the family Hominidae.""",
    "Ptr": """"Chimpanzee, sometimes colloquially
chimp, is the common name for the
two extant species of ape in the genus Pan.""",
    "Mms": """"A mouse is a small mammal belonging to the
order of rodents.""",
    "Cfa": """"The dog (Canis lupus familiaris) is a
domesticated subspecies of the Gray Wolf,
a member of the Canidae family of the
orderCarnivora.""",
}

# Creates my own layout function. I will use all previously created
# faces and will set different node styles depending on the type of
# node.
def mylayout(node):
    # If node is a leaf, add the nodes name and a its scientific
    # name
    if node.is_leaf():
        # Add an static face that handles the node name
        faces.add_face_to_node(nameFace, node, column=0)
        # We can also create faces on the fly
        longNameFace = faces.TextFace(code2name[node.name])
        faces.add_face_to_node(longNameFace, node, column=0)
```

```

# text faces support multiline. We add a text face
# with the whole description of each leaf.
descFace = faces.TextFace(code2desc[node.name], fsize=10)
descFace.margin_top = 10
descFace.margin_bottom = 10
descFace.border.margin = 1

# Note that this faces is added in "aligned" mode
faces.add_face_to_node(descFace, node, column=0, aligned=True)

# Sets the style of leaf nodes
node.img_style["size"] = 12
node.img_style["shape"] = "circle"
#If node is an internal node
else:
    # Sets the style of internal nodes
    node.img_style["size"] = 6
    node.img_style["shape"] = "circle"
    node.img_style["fgcolor"] = "#000000"

# If an internal node contains more than 4 leaves, add the
# images of the represented species sorted in columns of 2
# images max.
if len(node)>=4:
    col = 0
    for i, name in enumerate(set(node.get_leaf_names())):
        if i>0 and i%2 == 0:
            col += 1
        # Add the corresponding face to the node
        if name.startswith("Dme"):
            faces.add_face_to_node(flyFace, node, column=col)
        elif name.startswith("Dre"):
            faces.add_face_to_node(fishFace, node, column=col)
        elif name.startswith("Mms"):
            faces.add_face_to_node(mouseFace, node, column=col)
        elif name.startswith("Ptr"):
            faces.add_face_to_node(chimpFace, node, column=col)
        elif name.startswith("Hsa"):
            faces.add_face_to_node(humanFace, node, column=col)
        elif name.startswith("Cfa"):
            faces.add_face_to_node(dogFace, node, column=col)

    # Modifies this node's style
    node.img_style["size"] = 16
    node.img_style["shape"] = "sphere"
    node.img_style["fgcolor"] = "#AA0000"

# If leaf is "Hsa" (homo sapiens), highlight it using a
# different background.
if node.is_leaf() and node.name.startswith("Hsa"):
    node.img_style["bgcolor"] = "#9db0cf"

# And, finally, Visualize the tree using my own layout function
ts = TreeStyle()
ts.layout_fn = mylayout
t.render("img_faces.png", w=600, tree_style = ts)

```

Bubble tree maps

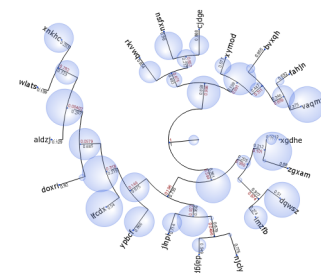

```

import random
from ete2 import Tree, TreeStyle, NodeStyle, faces, AttrFace, CircleFace

def layout(node):
    if node.is_leaf():
        # Add node name to leaf nodes
        N = AttrFace("name", fsize=14, fgcolor="black")
        faces.add_face_to_node(N, node, 0)
    if "weight" in node.features:
        # Creates a sphere face whose size is proportional to node's
        # feature "weight"
        C = CircleFace(radius=node.weight, color="RoyalBlue", style="sphere")
        # Let's make the sphere transparent
        C.opacity = 0.3
        # And place as a float face over the tree
        faces.add_face_to_node(C, node, 0, position="float")

def get_example_tree():
    # Random tree
    t = Tree()
    t.populate(20, random_branches=True)

    # Some random features in all nodes
    for n in t.traverse():
        n.add_features(weight=random.randint(0, 50))

    # Create an empty TreeStyle
    ts = TreeStyle()

    # Set our custom layout function
    ts.layout_fn = layout

    # Draw a tree
    ts.mode = "c"

    # We will add node names manually
    ts.show_leaf_name = False
    # Show branch data
    ts.show_branch_length = True
    ts.show_branch_support = True

    return t, ts

```

```

if __name__ == "__main__":
    t, ts = get_example_tree()

    #t.render("bubble_map.png", w=600, dpi=300, tree_style=ts)
    t.show(tree_style=ts)

```

Trees within trees

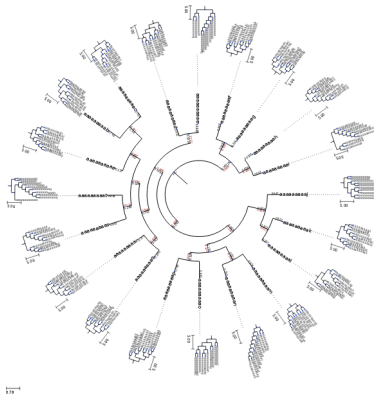

```

import random
from ete2 import Tree, TreeStyle, NodeStyle, faces, AttrFace, TreeFace

# Tree Style used to render small trees used as leaf faces
small_ts = TreeStyle()
small_ts.show_leaf_name = True
small_ts.scale = 10

def layout(node):
    if node.is_leaf():
        # Add node name to leaf nodes
        N = AttrFace("name", fsize=14, fgcolor="black")
        faces.add_face_to_node(N, node, 0)

        t = Tree()
        t.populate(10)

        T = TreeFace(t, small_ts)
        # Let's make the sphere transparent
        T.opacity = 0.8
        # And place as a float face over the tree
        faces.add_face_to_node(T, node, 1, position="aligned")

def get_example_tree():
    # Random tree
    t = Tree()
    t.populate(20, random_branches=True)

    # Some random features in all nodes
    for n in t.traverse():
        n.add_features(weight=random.randint(0, 50))

    # Create an empty TreeStyle
    ts = TreeStyle()

```

```

# Set our custom layout function
ts.layout_fn = layout

# Draw a tree
ts.mode = "c"

# We will add node names manually
ts.show_leaf_name = False
# Show branch data
ts.show_branch_length = True
ts.show_branch_support = True
return t, ts

if __name__ == "__main__":
    t, ts = get_example_tree()
    #t.render("tree_faces.png", w=600, dpi=300, tree_style=ts)
    t.show(tree_style=ts)

```

Phylogenetic trees and sequence domains

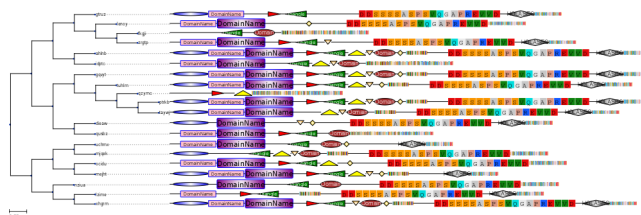

```

import sys

from ete2 import Tree, SeqMotifFace, TreeStyle, add_face_to_node

seq = "LHGRISQQVEQSRSQVQAIGEKVSLAQAKIEKIKGSKKAIAIKVFSSAKYPAPERLQEYGSIFTDAQDPGLQRRPRHR"
motifs = [
    # seq.start, seq.end, shape, width, height, fgcolor, bgcolor
    [10, 100, "[", None, 10, "black", "rgradient:blue", "arial|8|white domain Name"],
    [101, 150, "o", None, 10, "blue", "pink", None],
    [155, 180, ")", None, 10, "blue", "rgradient:purple", None],
    [160, 190, "^", None, 14, "black", "yellow", None],
    [172, 180, "v", None, 12, "black", "rgradient:orange", None],
    [185, 190, "o", None, 12, "black", "brown", None],
    [198, 200, "<>", None, 15, "black", "rgradient:gold", None],
    [210, 240, "compactseq", 2, 10, None, None, None],
    [300, 320, "seq", 10, 10, None, None, None],
    [310, 420, "<>", None, 30, "black", "rgradient:black", None],
    [1, 420, ")", None, 10, "red", "red", None],
    [11, 30, ")", None, 20, "blue", "blue", None],
    [300, 310, ")", None, 40, "green", "green", None],
]

def layout(node):
    if node.is_leaf():
        seqFace = SeqMotifFace(seq, motifs, scale_factor=1)
        add_face_to_node(seqFace, node, 0, position="aligned")

```



```

def get_example_tree():
    # Create a random tree and add to each leaf a random set of motifs
    # from the original set
    t = Tree()
    t.populate(10)
    # for l in t.iter_leaves():
    #     seq_motifs = [list(m) for m in motifs] #sample(motifs, randint(2, len(motifs)))

    #     seqFace = SeqMotifFace(seq, seq_motifs, intermotif_format="line",
    #                             seqtail_format="compactseq", scale_factor=1)
    #     seqFace.margin_bottom = 4
    #     f = l.add_face(seqFace, 0, "aligned")

    ts = TreeStyle()
    ts.layout_fn = layout
    return t, ts

if __name__ == '__main__':
    t, ts = get_example_tree()
    t.render("motifs.png", w=1200, dpi=300, tree_style=ts)
    #t.show(tree_style=ts)

```

Creating your custom interactive Item faces

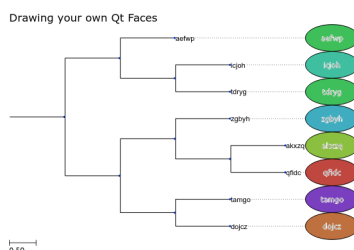

Note that item faces shown in this image are not static. When the tree is view using the `tree.show()` method, you can interact with items.

```

# We will need to create Qt4 items
from PyQt4 import QtCore
from PyQt4.QtGui import QGraphicsRectItem, QGraphicsSimpleTextItem, \
    QGraphicsEllipseItem, QColor, QPen, QBrush

from ete2 import Tree, faces, TreeStyle, NodeStyle

# To play with random colors
import colorsys
import random

class InteractiveItem(QGraphicsRectItem):
    def __init__(self, *arg, **karg):
        QGraphicsRectItem.__init__(self, *arg, **karg)
        self.node = None
        self.label = None
        self.setCursor(QtCore.Qt.PointingHandCursor)

```

```

        self.setAcceptsHoverEvents(True)

    def hoverEnterEvent(self, e):
        # There are many ways of adding interactive elements. With the
        # following code, I show/hide a text item over my custom
        # DynamicItemFace
        if not self.label:
            self.label = QGraphicsRectItem()
            self.label.setParentItem(self)
            # This is to ensure that the label is rendered over the
            # rest of item children (default ZValue for items is 0)
            self.label.setZValue(1)
            self.label.setBrush(QBrush(QColor("white")))
            self.label.text = QGraphicsSimpleTextItem()
            self.label.text.setParentItem(self.label)

            self.label.text.setText(self.node.name)
            self.label.setRect(self.label.text.boundingRect())
            self.label.setVisible(True)

    def hoverLeaveEvent(self, e):
        if self.label:
            self.label.setVisible(False)

    def random_color(h=None):
        """Generates a random color in RGB format."""
        if not h:
            h = random.random()
        s = 0.5
        l = 0.5
        return _hls2hex(h, l, s)

    def _hls2hex(h, l, s):
        return '#%02x%02x%02x' % tuple(map(lambda x: int(x*255),
                                           colorsys.hls_to_rgb(h, l, s)))

    def ugly_name_face(node, *args, **kwargs):
        """ This is my item generator. It must receive a node object, and
        returns a Qt4 graphics item that can be used as a node face.
        """

        # receive an arbitrary number of arguments, in this case width and
        # height of the faces
        width = args[0][0]
        height = args[0][1]

        ## Creates a main master Item that will contain all other elements
        ## Items can be standard QGraphicsItem
        # masterItem = QGraphicsRectItem(0, 0, width, height)

        # Or your custom Items, in which you can re-implement interactive
        # functions, etc. Check QGraphicsItem doc for details.
        masterItem = InteractiveItem(0, 0, width, height)

        # Keep a link within the item to access node info
        masterItem.node = node

```

```

# I dont want a border around the masterItem
masterItem.setPen(QPen(QtCore.Qt.NoPen))

# Add ellipse around text
ellipse = QGraphicsEllipseItem(masterItem.rect())
ellipse.setParentItem(masterItem)
# Change ellipse color
ellipse.setBrush(QBrush(QColor( random_color())))

# Add node name within the ellipse
text = QGraphicsSimpleTextItem(node.name)
text.setParentItem(ellipse)
text.setPen(QPen(QPen(QColor("white"))))

# Center text according to masterItem size
tw = text.boundingRect().width()
th = text.boundingRect().height()
center = masterItem.boundingRect().center()
text.setPos(center.x()-tw/2, center.y()-th/2)

return masterItem

def master_ly(node):
    if node.is_leaf():
        # Create an ItemFace. First argument must be the pointer to
        # the constructor function that returns a QGraphicsItem. It
        # will be used to draw the Face. Next arguments are arbitrary,
        # and they will be forwarded to the constructor Face function.
        F = faces.DynamicItemFace(ugly_name_face, 100, 50)
        faces.add_face_to_node(F, node, 0, position="aligned")

def get_example_tree():

    t = Tree()
    t.populate(8, reuse_names=False)

    ts = TreeStyle()
    ts.layout_fn = master_ly
    ts.title.add_face(faces.TextFace("Drawing your own Qt Faces", fsize=15), 0)
    return t, ts

if __name__ == "__main__":
    t, ts = get_example_tree()

    #t.render("item_faces.png", h=400, tree_style=ts)
    # The interactive features are only available using the GUI
    t.show(tree_style=ts)

```

2.3 Phylogenetic Trees

Contents

- *Phylogenetic Trees*
 - *Overview*
 - *Linking Phylogenetic Trees with Multiple Sequence Alignments*
 - *Visualization of phylogenetic trees*
 - *Adding taxonomic information*
 - * *Automatic control of species info*
 - * *Automatic (and custom) control of the species info*
 - * *Manual control of the species info*
 - *Detecting evolutionary events*
 - * *Species Overlap (SO) algorithm*
 - * *Tree reconciliation algorithm*
 - * *A closer look to the evolutionary event object*
 - *Relative dating phylogenetic nodes*
 - * *Implementation*
 - *Automatic rooting (outgroup detection)*
 - *Working with duplicated gene families*
 - * *Treeko (splitting gene trees into species trees)*
 - * *Splitting gene trees by duplication events*
 - * *Collapse species specific duplications*

2.3.1 Overview

Phylogenetic trees are the result of most evolutionary analyses. They represent the evolutionary relationships among a set of species or, in molecular biology, a set of homologous sequences.

The *PhyloTree* class is an extension of the base *Tree* object, providing a appropriate way to deal with phylogenetic trees. Thus, while leaves are considered to represent species (or sequences from a given species genome), internal nodes are considered ancestral nodes. A direct consequence of this is, for instance, that every split in the tree will represent a speciation or duplication event.

2.3.2 Linking Phylogenetic Trees with Multiple Sequence Alignments

PhyloTree instances allow molecular phylogenies to be linked to the Multiple Sequence Alignments (MSA). To associate a MSA with a phylogenetic tree you can use the *PhyloNode.link_to_alignment()* method. You can use the *alg_format* argument to specify its format (See *SeqGroup* documentation for available formats)

Given that Fasta format are not only applicable for MSA but also for **Unaligned Sequences**, you may also associate sequences of different lengths with tree nodes.

```
from ete2 import PhyloTree
fasta_txt = """
>seqA
MAEIPDETIQQFMALT---HNIAVQYLSEFGDLNEALNSYYASQTDDIKDRREEAH
>seqB
MAEIPDATIQQFMALTNVSHNIAVQY--EFGDLNEALNSYYAYQTDDQKDRREEAH
>seqC
MAEIPDATIQ---ALTNVSHNIAVQYLSEFGDLNEALNSYYASQTDDQPDRREEAH
>seqD
MAEAPDETIQQFMALTNVSHNIAVQYLSEFGDLNEAL-----REEAH
```

```
"""
# Load a tree and link it to an alignment.
t = PhyloTree("((seqA,seqB),seqC),seqD);")
t.link_to_alignment(alignment=fasta_txt, alg_format="fasta")
```

The same could be done at the same time the tree is being loaded, by using the alignment and alg_format arguments of *PhyloTree*.

```
# Load a tree and link it to an alignment.
t = PhyloTree("((seqA,seqB),seqC),seqD);", alignment=fasta_txt, alg_format="fasta")
```

As currently implemented, sequence linking process is not strict, which means that a perfect match between all node names and sequences names **is not required**. Thus, if only one match is found between sequences names within the MSA file and tree node names, only one tree node will contain an associated sequence. Also, it is important to note that sequence linking is not limited to terminal nodes. If internal nodes are named, and such names find a match within the provided MSA file, their corresponding sequences will be also loaded into the tree structure. Once a MSA is linked, sequences will be available for every tree node through its node .sequence attribute.

```
from ete2 import PhyloTree
fasta_txt = """
>seqA
MAEIPDETIQQFMALT---HNIQVQYLSEFGDLNEALNSYYASQTDDIKDRREEAH
>seqB
MAEIPDATIQQFMALTNVSHNIAVQY--EFGDLNEALNSYYAYQTDDQKDRREEAH
>seqC
MAEIPDATIQ---ALTNVSHNIAVQYLSEFGDLNEALNSYYASQTDDQPDRREEAH
>seqD
MAEAPDETIQQFMALTNVSHNIAVQYLSEFGDLNEAL-----REEAH
"""
iphylip_txt = """
4 76
    seqA  MAEIPDETIQ  QFMALT---H  NIAVQYLSEF  GDLNEALNSY  YASQTDDIKD  RREEAHQFMA
    seqB  MAEIPDATIQ  QFMALTNVSH  NIAVQY--EF  GDLNEALNSY  YAYQTDDQKD  RREEAHQFMA
    seqC  MAEIPDATIQ  ---ALTNVSH  NIAVQYLSEF  GDLNEALNSY  YASQTDDQPD  RREEAHQFMA
    seqD  MAEAPDETIQ  QFMALTNVSH  NIAVQYLSEF  GDLNEAL---  -----  -REEAHQ---
          LTNVSHQFMA  LTNVSH
          LTNVSH----  -----
          LTNVSH----  -----
          -----FMA  LTNVSH
"""
# Load a tree and link it to an alignment. As usual, 'alignment' can
# be the path to a file or data in text format.
t = PhyloTree("((seqA,seqB),seqC),seqD);", alignment=fasta_txt, alg_format="fasta")

#We can now access the sequence of every leaf node
print "These are the nodes and its sequences:"
for leaf in t.iter_leaves():
    print leaf.name, leaf.sequence
#seqD MAEAPDETIQQFMALTNVSHNIAVQYLSEFGDLNEAL-----REEAH
#seqC MAEIPDATIQ---ALTNVSHNIAVQYLSEFGDLNEALNSYYASQTDDQPDRREEAH
#seqA MAEIPDETIQQFMALT---HNIQVQYLSEFGDLNEALNSYYASQTDDIKDRREEAH
#seqB MAEIPDATIQQFMALTNVSHNIAVQY--EFGDLNEALNSYYAYQTDDQKDRREEAH
#
# The associated alignment can be changed at any time
t.link_to_alignment(alignment=iphylip_txt, alg_format="iphylip")
```

```
# Let's check that sequences have changed
print "These are the nodes and its re-linked sequences:"
for leaf in t.iter_leaves():
    print leaf.name, leaf.sequence
#seqD MAEAPDETIQQFMALTNVSHNIAVQYLSEFGDLNEAL-----REEAHQ-----FMALTNVSH
#seqC MAEIPDATIQ---ALTNVSHNIAVQYLSEFGDLNEALNSYYASQTDDQPDRREEAHQFMALTNVSH-----
#seqA MAEIPDETIQQFMALT---HNIAVQYLSEFGDLNEALNSYYASQTDDIKDRREEAHQFMALTNVSHQFMALTNVSH
#seqB MAEIPDATIQQFMALTNVSHNIAVQY--EFGDLNEALNSYYAYQTDDQKDRREEAHQFMALTNVSH-----
#
# The sequence attribute is considered as node feature, so you can
# even include sequences in your extended newick format!
print t.write(features=["sequence"], format=9)
#
#
# ((seqA[&&NHX:sequence=MAEIPDETIQQFMALT---HNIAVQYLSEFGDLNEALNSYYASQTDDIKDRREEAHQF
# MALTNVSHQFMALTNVSH], seqB[&&NHX:sequence=MAEIPDATIQQFMALTNVSHNIAVQY--EFGDLNEALNSY
# YAYQTDDQKDRREEAHQFMALTNVSH-----]), seqC[&&NHX:sequence=MAEIPDATIQ---ALTNVSHNIA
# VQYLSEFGDLNEALNSYYASQTDDQPDRREEAHQFMALTNVSH-----]), seqD[&&NHX:sequence=MAEAPD
# ETIQQFMALTNVSHNIAVQYLSEFGDLNEAL-----REEAHQ-----FMALTNVSH]);
#
# And yes, you can save this newick text and reload it into a PhyloTree instance.
sametree = PhyloTree(t.write(features=["sequence"]))
print "Recovered tree with sequence features:"
print sametree
#
#
#                                     /-seqA
#                                 /-----|
#                             /-----|   \-seqB
#                         /-----|
#                   /-----|   \-seqC
#             /-----|
#         /-----|
#     /-----|
#   /-----|
# /-----|
#
print "seqA sequence:", (t."&seqA").sequence
# MAEIPDETIQQFMALT---HNIAVQYLSEFGDLNEALNSYYASQTDDIKDRREEAHQFMALTNVSHQFMALTNVSH
```

2.3.3 Visualization of phylogenetic trees

PhyloTree instances can benefit from all the features of the programmable drawing engine. However, a built-in phylogenetic layout is provided for convenience.

All PhyloTree instances are, by default, attached to such layout for tree visualization, thus allowing for in-place alignment visualization and evolutionary events labeling.

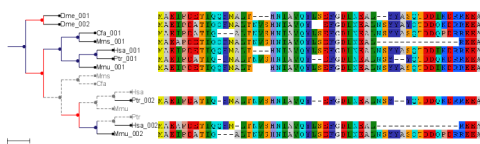

```
from ete2 import PhyloTree, TreeStyle

alg = ""
>Dme_001
MAEIPDETIQQFMALT---HNIAVQYLSEFGDLNEAL--YYASQTDDIKDRREEAH
>Dme_002
```

```

MAEIPDATIQQFMALTNVSHNIAVQY--EFGDLNEALNSYYAYQTDDQKDRREEAH
>Cfa_001
MAEIPDATIQ---ALTNVSHNIAVQYLSEFGDLNEALNSYYASQTDDQPDRREEAH
>Mms_001
MAEAPDETIQQFMALTNVSHNIAVQYLSEFGDLNEAL-----REEAH
>Hsa_001
MAEIPDETIQQFMALT---HNIQVQYLSEFGDLNEALNSYYASQTDDIKDRREEAH
>Ptr_002
MAEIPDATIQ-FMALTNVSHNIAVQY--EFGDLNEALNSY--YQTDDQKDRREEAH
>Mmu_002
MAEIPDATIQ---ALTNVSHNIAVQYLSEFGDLNEALNSYYASQTDDQPDRREEAH
>Hsa_002
MAEAPDETIQQFM-LTNVSHNIAVQYLSEFGDLNEAL-----REEAH
>Mmu_001
MAEIPDETIQQFMALT---HNIQVQYLSEFGDLNEALNSYYASQTDDIKDRREEAH
>Ptr_001
MAEIPDATIQ-FMALTNVSHNIAVQY--EFGDLNEALNSY--YQTDDQKDRREEAH
>Mmu_001
MAEIPDATIQ---ALTNVSHNIAVQYLSEFGDLNEALNSYYASQTDDQPDRREEAH
"""

def get_example_tree():

    # Performs a tree reconciliation analysis
    gene_tree_nw = '((Dme_001,Dme_002),((Cfa_001,Mms_001),((Hsa_001,Ptr_001),Mmu_001)),
    species_tree_nw = "(((Hsa, Ptr), Mmu), (Mms, Cfa)), Dme);"
    genetree = PhyloTree(gene_tree_nw)
    sptree = PhyloTree(species_tree_nw)
    recon_tree, events = genetree.reconcile(sptree)
    recon_tree.link_to_alignment(alg)
    return recon_tree, TreeStyle()

if __name__ == "__main__":
    # Visualize the reconciled tree
    t, ts = get_example_tree()
    t.show(tree_style=ts)
    #recon_tree.render("phylotree.png", w=750)

```

2.3.4 Adding taxonomic information

PhyloTree instances allow to deal with leaf names and species names separately. This is useful when working with molecular phylogenies, in which node names usually represent sequence identifiers. Species names will be stored in the *PhyloNode.species* attribute of each leaf node. The method *PhyloNode.get_species()* can be used obtain the set of species names found under a given internal node (speciation or duplication event). Often, sequence names do contain species information as a part of the name, and ETE can parse this information automatically.

There are three ways to establish the species of the different tree nodes:

- Default: The three first letters of node's name represent the species
- The species code of each node is dynamically created based on node's name
- The species code of each node is manually set.

Automatic control of species info

```

from ete2 import PhyloTree
# Reads a phylogenetic tree (using default species name encoding)
t = PhyloTree("((Hsa_001,Ptr_001),(Cfa_001,Mms_001)),(Dme_001,Dme_002));")
#
#                               /-Hsa_001
#                               /-----|
#                               |         \-Ptr_001
#                               /-----|
#                               |         /-Cfa_001
#                               |         \-----|
#-----|                         \-Mms_001
#                               /-Dme_001
#                               /-----|
#                               |         \-Dme_002
#
# Prints current leaf names and species codes
print "Deafault mode:"
for n in t.get_leaves():
    print "node:", n.name, "Species name:", n.species
# node: Dme_001 Species name: Dme
# node: Dme_002 Species name: Dme
# node: Hsa_001 Species name: Hsa
# node: Ptr_001 Species name: Ptr
# node: Cfa_001 Species name: Cfa
# node: Mms_001 Species name: Mms

```

Automatic (and custom) control of the species info

The default behavior can be changed by using the `PhyloNode.set_species_naming_function()` method or by using the `sp_naming_function` argument of the `PhyloTree` class. Note that, using the `sp_naming_function` argument, the whole tree structure will be initialized to use the provided parsing function to obtain species name information. `PhyloNode.set_species_naming_function()` (present in all tree nodes) can be used to change the behavior in a previously loaded tree, or to set different parsing function to different parts of the tree.

```

from ete2 import PhyloTree
# Reads a phylogenetic tree
t = PhyloTree("((Hsa_001,Ptr_001),(Cfa_001,Mms_001)),(Dme_001,Dme_002));")

# Let's use our own leaf name parsing function to obtain species
# names. All we need to do is create a python function that takes
# node's name as argument and return its corresponding species name.
def get_species_name(node_name_string):
    # Species code is the first part of leaf name (separated by an
    # underscore character)
    spcode = node_name_string.split("_")[0]
    # We could even translate the code to complete names
    code2name = {
        "Dme": "Drosophila melanogaster",
        "Hsa": "Homo sapiens",
        "Ptr": "Pan troglodytes",
        "Mms": "Mus musculus",
    }

```



```

        "Cfa":"Canis familiaris"
    }
    return code2name[scode]

# Now, let's ask the tree to use our custom species naming function
t.set_species_naming_function(get_species_name)
print "Custom mode:"
for n in t.get_leaves():
    print "node:", n.name, "Species name:", n.species

# node: Dme_001 Species name: Drosophila melanogaster
# node: Dme_002 Species name: Drosophila melanogaster
# node: Hsa_001 Species name: Homo sapiens
# node: Ptr_001 Species name: Pan troglodytes
# node: Cfa_001 Species name: Canis familiaris
# node: Mms_001 Species name: Mus musculus

```

Manual control of the species info

To disable the automatic generation of species names based on node names, a `None` value can be passed to the `PhyloNode.set_species_naming_function()` function. From then on, species attribute will not be automatically updated based on the name of nodes and it could be controlled manually.

```

from ete2 import PhyloTree
# Reads a phylogenetic tree
t = PhyloTree("((Hsa_001,Ptr_001),(Cfa_001,Mms_001)),(Dme_001,Dme_002));")

# Of course, you can disable the automatic generation of species
# names. To do so, you can set the species naming function to
# None. This is useful to set the species names manually or for
# reading them from a newick file. Other wise, species attribute would
# be overwritten
mynewick = """
(((Hsa_001[&&NHX:species=Human],Ptr_001[&&NHX:species=Chimp]),
(Cfa_001[&&NHX:species=Dog],Mms_001[&&NHX:species=Mouse])),
(Dme_001[&&NHX:species=Fly],Dme_002[&&NHX:species=Fly]));
"""
t = PhyloTree(mynewick, sp_naming_function=None)
print "Disabled mode (manual set)"
for n in t.get_leaves():
    print "node:", n.name, "Species name:", n.species

# node: Dme_001 Species name: Fly
# node: Dme_002 Species name: Fly
# node: Hsa_001 Species name: Human
# node: Ptr_001 Species name: Chimp
# node: Cfa_001 Species name: Dog
# node: Mms_001 Species name: Mouse

```

Full Example: Species aware trees.

2.3.5 Detecting evolutionary events

There are several ways to automatically detect duplication and speciation nodes. ETE provides two methodologies: One implements the algorithm described in [Huerta-Cepas \(2007\)](#) and is based on the species overlap (SO) between partitions and thus does not depend on the availability of a species tree. The second, which requires the comparison between the gene tree and a previously defined species tree, implements a strict tree reconciliation algorithm (Page and Charleston, 1997). By detecting evolutionary events, orthology and paralogy relationships among sequences can also be inferred. Find a comparison of both methods in [Marcet-Houben and Gabaldon \(2009\)](#).

Species Overlap (SO) algorithm

In order to apply the SO algorithm, you can use the `PhyloNode.get_descendant_evolution_events()` method (it will detect all evolutionary events under the current node) or the `PhyloNode.get_my_evolution_events()` method (it will detect only the evolutionary events in which current node, a leaf, is involved).

By default the **species overlap score (SOS) threshold** is set to 0.0, which means that a single species in common between two node branches will rise a duplication event. This has been shown to perform the best with real data, however you can adjust the threshold using the `sos_thr` argument present in both methods.

```
from ete2 import PhyloTree
# Loads an example tree
nw = """
((Dme_001,Dme_002),((Cfa_001,Mms_001),((Hsa_001,Ptr_001),Mmu_001)),
(Ptr_002,(Hsa_002,Mmu_002)));
"""
t = PhyloTree(nw)
print t
#
#                               /-Dme_001
#                               /-----|
#                               |         \-Dme_002
#                               |
#                               |
#                               |                               /-Cfa_001
#                               |                               /-----|
#-----|                               |         \-Mms_001
#                               |         /-----|
#                               |         |         |
#                               |         |         |                               /-Hsa_001
#                               |         |         |         /-----|
#                               |         |         |         \-Ptr_001
#                               |         |         |         |
#                               |         |         |         |         \-Mmu_001
#                               |         |         |         |
#                               |         |         |         |         /-Ptr_002
#                               |         |         |         |         /-----|
#                               |         |         |         |         |         /-Hsa_002
#                               |         |         |         |         |         /-----|
#                               |         |         |         |         |         \-Mmu_002
#
# To obtain all the evolutionary events involving a given leaf node we
# use get_my_evolution_events method
matches = t.search_nodes(name="Hsa_001")
human_seq = matches[0]
# Obtains its evolutionary events
```

```

events = human_seq.get_my_evolution_events()
# Print its orthology and paralogy relationships
print "Events detected that involve Hsa_001:"
for ev in events:
    if ev.etype == "S":
        print '    ORTHOLOGY RELATIONSHIP:', ', '.join(ev.in_seqs), "<====>", ', '.join(ev.out_seqs)
    elif ev.etype == "D":
        print '    PARALOGY RELATIONSHIP:', ', '.join(ev.in_seqs), "<====>", ', '.join(ev.out_seqs)

# Alternatively, you can scan the whole tree topology
events = t.get_descendant_evolution_events()
# Print its orthology and paralogy relationships
print "Events detected from the root of the tree"
for ev in events:
    if ev.etype == "S":
        print '    ORTHOLOGY RELATIONSHIP:', ', '.join(ev.in_seqs), "<====>", ', '.join(ev.out_seqs)
    elif ev.etype == "D":
        print '    PARALOGY RELATIONSHIP:', ', '.join(ev.in_seqs), "<====>", ', '.join(ev.out_seqs)

# If we are only interested in the orthology and paralogy relationship
# among a given set of species, we can filter the list of sequences
#
# fseqs is a function that, given a list of sequences, returns only
# those from human and mouse
fseqs = lambda slist: [s for s in slist if s.startswith("Hsa") or s.startswith("Mms")]
print "Paralogy relationships among human and mouse"
for ev in events:
    if ev.etype == "D":
        # Prints paralogy relationships considering only human and
        # mouse. Some duplication event may not involve such species,
        # so they will be empty
        print '    PARALOGY RELATIONSHIP:', \
            ', '.join(fseqs(ev.in_seqs)), \
            "<====>", \
            ', '.join(fseqs(ev.out_seqs))

# Note that besides the list of events returned, the detection
# algorithm has labeled the tree nodes according with the
# predictions. We can use such labels as normal node features.
dups = t.search_nodes(evolution_type="D") # Return all duplication nodes

```

Tree reconciliation algorithm

Tree reconciliation algorithm uses a predefined species tree to infer all the necessary genes losses that explain a given gene tree topology. Consequently, duplication and separation nodes will strictly follow the species tree topology.

To perform a tree reconciliation analysis over a given node in a molecular phylogeny you can use the `PhyloNode.reconcile()` method, which requires a species `PhyloTree` as its first argument. Leaf node names in the the species are expected to be the same species codes in the gene tree (see *taxonomic_info*). All species codes present in the gene tree should appear in the species tree.

As a result, the `PhyloNode.reconcile()` method will label the original gene tree nodes as duplication or speciation, will return the list of inferred events, and will return a new **reconciled tree** (`PhyloTree` instance), in which inferred gene losses are present and labeled.

```
#           /           /           /
#           /           /           \-Mmu_001
#          \-----/
#           /           /           /-Mms
#           /           /           /-----/
#           /           /           \-Cfa
#           /           /           /
#          \-----/           /-----/           /-Hsa
#           /           /           /-----/           \-Ptr_002
#           /           /           /           |
#           /           /           \-Mmu
#          \-----/           /-----/           /-Ptr
#           /           /           /-----/           \-Hsa_002
#           /           /           |
#           /           /           \-Mmu_002
#
# And we can visualize the trees using the default phylogeny
# visualization layout
genetree.show()
recon_tree.show()
```

A closer look to the evolutionary event object

Both methods, species overlap and tree reconciliation, can be used to label each tree node as a duplication or speciation event. Thus, the `PhyloNode.evoltype` attribute of every node will be set to one of the following states: D (Duplication), S (Speciation) or L gene loss.

Additionally, a list of all the detected events is returned. Each event is a python object of type `phylo.EvolEvent`, containing some basic information about each event (`etype`, `in_seqs`, `out_seqs`, `node`):

If an event represents a duplication, `in_seqs` **are all paralogous** to `out_seqs`. Similarly, if an event represents a speciation, `in_seqs` **are all orthologous** to `out_seqs`.

2.3.6 Relative dating phylogenetic nodes

In molecular phylogeny, nodes can be interpreted as evolutionary events. Therefore, they represent duplication or speciation events. In the case of gene duplication events, nodes can also be assigned to a certain point in a relative temporal scale. In other words, you can obtain a relative dating of all the duplication events detected.

Although **absolute dating is always preferred and more precise**, topological dating provides a faster approach to compare the relative age of paralogous sequences ([read this](#) for a comparison with other methods, such as the use of synonymous substitution rates as a proxy to the divergence time).

Some applications of topological dating can be found in [Huerta-Cepas et al, 2007](#) or, more recently, in [Huerta-Cepas et al, 2011](#) or [Kalinka et al, 2001](#).

Implementation

The aim of relative dating is to establish a gradient of ages among sequences. For this, a reference species needs to be fixed, so the gradient of ages will be referred to that referent point.

Thus, if our reference species is *Human*, we could establish the following gradient of species:

- (1) Human -> (2) Other Primates -> (3) Mammals -> (4) Vertebrates

So, nodes in a tree can be assigned to one of the above categories depending on the sequences grouped. For instance:

- A node with only human sequences will be mapped to (1).
- A node with human and orangutan sequences will be mapped to (2)
- A node with human a fish sequences will be mapped to (4)

This simple calculation can be done automatically by encoding the gradient of species ages as Python dictionary.

```
relative_dist = {
    "human": 0, # human
    "chimp": 1, # Primates non human
    "rat": 2, # Mammals non primates
    "mouse": 2, # Mammals non primates
    "fish": 3 # Vertebrates non mammals
}
```

Once done, ETE can check the relative age of any tree node. The `PhyloNode.get_age()` method can be used to that purpose.

For example, let's consider the following gene tree:

```
#
#                               /-humanA
#                               /---|
#                               |     \-chimpA
#                               /Dup1
#                               |     |     /-humanB
#                               /---|     \---|
#                               |     |     \-chimpB
#                               /---|     |
#                               |     |     \-mouseA
#                               |     |
#                               |     \-fish
#-Dup3
#                               /-humanC
#                               /---|
#                               /---|     \-chimpC
#                               |     |
#                               \Dup2     \-humanD
#                               |
#                               /-ratC
#                               \---|
#                               \-mouseC
```

the expected node dating would be:

- Dup1 will be assigned to primates (most distant species is chimp).
Dup1.get_age(relative_distances) will return 1

```
# We can translate each number to its correspondig taxonomic number
age2name = {
    1:"hominids",
    2:"primates",
    3:"mammals",
    4:"metazoa"
}
event1= t.get_common_ancestor("Hsa_001", "Hsa_004")
event2=t.get_common_ancestor("Hsa_001", "Hsa_002")
print
print "The duplication event leading to the human sequences Hsa_001 and "+\
      "Hsa_004 is dated at: ", age2name[event1.get_age(species2age)]
print "The duplication event leading to the human sequences Hsa_001 and "+\
      "Hsa_002 is dated at: ", age2name[event2.get_age(species2age)]
# The duplication event leading to the human sequences Hsa_001 and Hsa_004
# is dated at: primates
#
# The duplication event leading to the human sequences Hsa_001 and Hsa_002
# is dated at: mammals
```

Warning: Note that relative distances will vary depending on your reference species.

2.3.7 Automatic rooting (outgroup detection)

Two methods are provided to assist in the automatic rooting of phylogenetic trees. Since tree nodes contain relative age information (based on the species code autodetection), the same relative age dictionaries can be used to detect the farthest and oldest node in a tree to given sequences.

`PhyloNode.get_farthest_oldest_node()` and `PhyloNode.get_farthest_oldest_leaf()` can be used for that purpose.

2.3.8 Working with duplicated gene families

Treeko (splitting gene trees into species trees)

Comparisons between tree topologies provide important information for many evolutionary studies. Treeko (Marcet and Gabaldon, 2011) is a novel method that allows the comparison of any two tree topologies, even those with missing leaves and duplications. This is important in genome-wide analysis since many trees do not have exact leaf pairings and therefore most tree comparison methods are rendered useless.

Although Treeko is available as a standalone package, it uses ETE to generate all possible species tree topologies within a duplicated gene family tree.

Thus, the ETE method `PhyloNode.get_speciation_trees()` is expected to provide the core functionality required to perform a Treeko analysis. When used, the method will return a list of all possible species trees observed after combining the different non-duplicated subparts under a gene family tree node.

Duplication events will be automatically identified using the species overlap algorithm described within this manual. However, duplication nodes can be manually labeled and used by disabling the `autodetect_duplication` flag.

Because of the combinatorial background of the Treeko method, the number of speciation trees generated by this function may vary enormously (ranging from few hundreds to tens of thousands topologies).

Here is a basic example on how to use it:

```

from ete2 import PhyloTree
t = PhyloTree("(((Human_1, Chimp_1), (Human_2, (Chimp_2, Chimp_3))), ((Fish_1, (Human_3, Yeast_1)), (Human_2, Yeast_2))), (Human_1, Human_2))
t.set_species_naming_function(lambda node: node.name.split("_")[0] )

print t.get_ascii(attributes=["name", "species"], show_internal=False )

#           /-Human_1, Human
#           /-|
#           |  \-Chimp_1, Chimp
#           /-|
#           |  |  /-Human_2, Human
#           |  |  \-|
#           |  |  |  /-Chimp_2, Chimp
#           |  |  |  \-|
#           |  |  |  \-Chimp_3, Chimp
#           |  |  |
#           |  |  |  /-Fish_1, Fish
#           |  |  |  /-|
#           |  |  |  |  |  /-Human_3, Human
#           --|  \-|  \-|
#           |  |  |  \-Fish_3, Fish
#           |  |  |
#           |  |  |  \-Yeast_2, Yeast
#           |  |  |
#           |  |  |  \-Yeast_1, Yeast

# We obtain a list of species trees inferred from the duplication
# events. Note that species specific duplications are ignored.

ntrees, ndups, sptrees = t.get_speciation_trees()
print "Found %d species trees and %d duplication nodes" %(ntrees, ndups)
for spt in sptrees:
    print spt

# Found 5 species trees and 4 duplication nodes
#
#           /-Human_1
#           --|
#           |  \-Chimp_1
#           #
#           /-Human_2
#           --|
#           |  /-Chimp_2
#           |  \-|
#           |  |  \-Chimp_3
#           #
#           /-Fish_1
#           --|
#           |  \-Yeast_2
#           #
#           |  |  /-Human_3
#           |  |  /-|
#           --|  \-Fish_3

```

```
# |
#  \-Yeast_2
#
# --Yeast_1
```

Note: For performance reasons, species trees are created without any link to the original gene family tree, rather than the species name of each node. However, the `map_features` attribute can be used to keep certain attributes of the original tree into the generated species trees.

Note: Although the efficiency of the method to generate all possible trees has been significantly improved from ETE version 2.2, creating thousands of new `PhyloTree` objects could affect performance. The flag `newick_only` is now available to limit the output to a newick string per generated tree, thus improving the speed they can be processed or dumped into a file.

Splitting gene trees by duplication events

A much simpler approach to separate duplicates within the same gene family tree is to split the topology by their duplication nodes. For this, the method `PhyloNode.split_by_dups()` is provided.

```
from ete2 import PhyloTree
t = PhyloTree("(((Human_1, Chimp_1), (Human_2, (Chimp_2, Chimp_3))), ((Fish_1, (Human_3, Chimp_2)), (Human_1, Chimp_1)))")
t.set_species_naming_function(lambda node: node.name.split("_")[0] )

print t.get_ascii(attributes=["name", "species"], show_internal=False )

#          /-Human_1, Human
#          /-|
#          |  \-Chimp_1, Chimp
#          /-|
#          |  |  /-Human_2, Human
#          |  |  \-|
#          |  |  |  /-Chimp_2, Chimp
#          |  |  |  \-|
#          /-|  |  \-Chimp_3, Chimp
#          |  |
#          |  |  /-Fish_1, Fish
#          |  |  /-|
#          |  |  |  |  /-Human_3, Human
#          --|  \-|  \-|
#          |  |  |  \-Fish_3, Fish
#          |  |  |
#          |  |  \-Yeast_2, Yeast
#          |  |
#          \-Yeast_1, Yeast

# Again, species specific duplications are ignored
for node in t.split_by_dups():
    print node

#  /-Human_1
# --|
#  \-Chimp_1
#
```

```
#      /-Human_2
# --|
#     |      /-Chimp_2
#     \-|
#         \-Chimp_3
#
# --Yeast_2
#
# --Fish_1
#
#      /-Human_3
# --|
#     \-Fish_3
#
# --Yeast_1
```

Collapse species specific duplications

The method `PhyloNode.collapse_lineage_specific_expansions()` method, which returns a pruned version of a tree, where nodes representing lineage specific expansions are converted into a single leaf node is also available.

From the previous examples, the lineage specific duplication of Chimp_1 and Chimp_2 could be easily collapsed into a single node.

```
from ete2 import PhyloTree
t = PhyloTree("(((Human_1, Chimp_1), (Human_2, (Chimp_2, Chimp_3))), ((Fish_1, (Human_3
t.set_species_naming_function(lambda node: node.name.split("_")[0] )

print t.get_ascii(attributes=["name", "species"], show_internal=False )

#           /-Human_1, Human
#           /-|
#           |   \-Chimp_1, Chimp
#           /-|
#           |   |   /-Human_2, Human
#           |   \-|
#           |       |   /-Chimp_2, Chimp
#           |       \-|
#           /-|           \-Chimp_3, Chimp
#           |   |
#           |   |   /-Fish_1, Fish
#           |   /-|
#           |   |   |   /-Human_3, Human
# --|   \-|   \-|
#       |       |   \-Fish_3, Fish
#       |       |
#       |       \-Yeast_2, Yeast
#       |
#       \-Yeast_1, Yeast

t2 = t.collapse_lineage_specific_expansions()
print t2.get_ascii(attributes=["name", "species"], show_internal=False )

#           /-Human_1, Human
#           /-|
```

```
#      |      \-Chimp_1, Chimp
#      /-|
#      | |      /-Human_2, Human
#      |      \-|
#      |          \-Chimp_2, Chimp    ***
#      /-|
#      | |      /-Fish_1, Fish
#      | |      /-|
#      | | | |      /-Human_3, Human
# --|      \-|      \-|
#      |          \-Fish_3, Fish
#      |          |
#      |          \-Yeast_2, Yeast
#      |
#      \-Yeast_1, Yeast
```

2.4 Clustering Trees

Contents

- *Clustering Trees*
 - *Overview*
 - *Loading ClusterTrees*
 - *Visualization of matrix associated Trees*
 - *Cluster Validation Example*

2.4.1 Overview

Cluster analysis is the assignment of a set of observations into subsets (called clusters) so that observations in the same cluster are similar in some sense. Clustering is a method of unsupervised learning, and a common technique for statistical data analysis used in many fields, including machine learning, data mining, pattern recognition, image analysis and bioinformatics. Hierarchical clustering creates a hierarchy of clusters which may be represented in a tree structure called a dendrogram. The root of the tree consists of a single cluster containing all observations, and the leaves correspond to individual observations. [The Wikipedia project Jun-2009].

ETE provides special *ClusterNode* (alias *ClusterTree*) instances to deal with trees associated to a clustering analysis. The basic difference between *Tree* and *ClusterTree* is that leaf nodes in a cluster-tree are linked to numerical profiles. Such profiles are expected to represent the data used to generate the clustering tree. In other words, trees are bound to numerical arrays.

```
#      /-A
#      ---|
#      \-B
#
# #Names  col1  col2  col3
# A      1.1   0.1   1.33
# B      2.0   1.0   2.0
```

Based on this, *ClusterTree* instances provide several clustering validation techniques that help in the analysis of cluster quality. Currently, inter and intra-cluster distances, cluster std.deviation,

Silhouette analysis and Dunn indexes are supported. In addition, ClusterTree nodes can be visualized using the *ProfileFace* face type, which can represent cluster profiles in different ways, such as line plots, heatmaps or bar plots.

Although this type of trees are intended to be used for clustering results, any tree that can be linked to a table (i.e. phylogenetic profiles) could be loaded using this data type, thus taking advantage of the profile visualization modes, etc.

2.4.2 Loading ClusterTrees

A *ClusterTree* can be linked to a numerical matrix by using the `text_array` argument.

```
from ete2 import ClusterTree

# Example of a minimalistic numerical matrix. It is encoded as a text
# string for convenience, but it usally be loaded from a text file.
matrix = """
#Names\tcol1\tcol2\tcol3\tcol4\tcol5\tcol6\tcol7
A\t-1.23\t-0.81\t1.79\t0.78\t-0.42\t-0.69\t0.58
B\t-1.76\t-0.94\t1.16\t0.36\t0.41\t-0.35\t1.12
C\t-2.19\t0.13\t0.65\t-0.51\t0.52\t1.04\t0.36
D\t-1.22\t-0.98\t0.79\t-0.76\t-0.29\t1.54\t0.93
E\t-1.47\t-0.83\t0.85\t0.07\t-0.81\t1.53\t0.65
F\t-1.04\t-1.11\t0.87\t-0.14\t-0.80\t1.74\t0.48
G\t-1.57\t-1.17\t1.29\t0.23\t-0.20\t1.17\t0.26
H\t-1.53\t-1.25\t0.59\t-0.30\t0.32\t1.41\t0.77
"""

print "Example numerical matrix"
print matrix
# #Names  col1    col2    col3    col4    col5    col6    col7
# A      -1.23   -0.81    1.79    0.78   -0.42   -0.69    0.58
# B      -1.76   -0.94    1.16    0.36    0.41   -0.35    1.12
# C      -2.19    0.13    0.65   -0.51    0.52    1.04    0.36
# D      -1.22   -0.98    0.79   -0.76   -0.29    1.54    0.93
# E      -1.47   -0.83    0.85    0.07   -0.81    1.53    0.65
# F      -1.04   -1.11    0.87   -0.14   -0.80    1.74    0.48
# G      -1.57   -1.17    1.29    0.23   -0.20    1.17    0.26
# H      -1.53   -1.25    0.59   -0.30    0.32    1.41    0.77
#
#
# We load a tree structure whose leaf nodes correspond to rows in the
# numerical matrix. We use the text_array argument to link the tree
# with numerical matrix.
t = ClusterTree("((A,B),(C,(D,E))),(F,(G,H));", text_array=matrix)
```

Alternatively, you can re-link the tree (or a sub-part of it) to a new matrix using the *ClusterNode.link_to_arraytable()* method.

```
t = ClusterTree("((A,B),(C,(D,E))),(F,(G,H));")
t.children[0].link_to_arraytable(matrix1)
t.children[1].link_to_arraytable(matrix2)
```

Once the tree is linked to a table of profiles, the following node properties will be available: `PhyloNode.profile`, `PhyloNode.deviation`, `PhyloNode.silhouette`, `PhyloNode.intercluster_dist`, `PhyloNode.intracluster_dist`, `PhyloNode.dunn`.

Similarly, the following methods are provide for convenience `PhyloNode.iter_leaf_profiles()`, `PhyloNode.get_leaf_profiles()`, `PhyloNode.get_silhouette()` and `PhyloNode.get_dunn()` methods.

2.4.3 Visualization of matrix associated Trees

Clustering or not, any `ClusterTree` instance, associated to a numerical matrix, can be visualized together with the graphical representation of its node's numeric profiles. To this end, the `ProfileFace` class is provided by the `treeview` module. This face type can represent a node's numeric profile in four different ways:

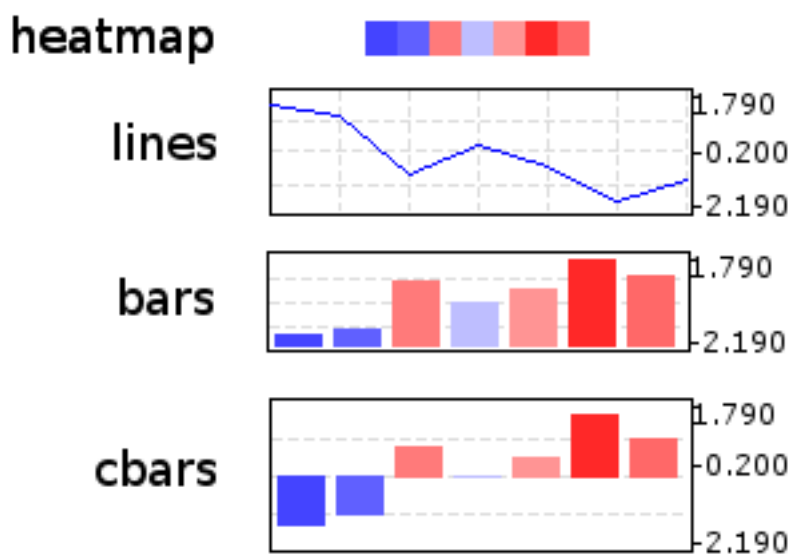

Additionally, three basic layouts are provided that use different styles of `ProfileFace` instances: **heatmap**, **line_profiles**, **bar_profiles**, **cbar_profiles**.

```
# Import Tree instance and faces module
from ete2 import ClusterTree
# Example of a minimalistic numerical matrix. It is encoded as a text
# string for convenience, but it usally be loaded from a text file.
matrix = """
#Names\tcol1\tcol2\tcol3\tcol4\tcol5\tcol6\tcol7
A\t-1.23\t-0.81\t1.79\t0.78\t-0.42\t-0.69\t0.58
B\t-1.76\t-0.94\t1.16\t0.36\t0.41\t-0.35\t1.12
C\t-2.19\t0.13\t0.65\t-0.51\t0.52\t1.04\t0.36
D\t-1.22\t-0.98\t0.79\t-0.76\t-0.29\t1.54\t0.93
E\t-1.47\t-0.83\t0.85\t0.07\t-0.81\t1.53\t0.65
F\t-1.04\t-1.11\t0.87\t-0.14\t-0.80\t1.74\t0.48
G\t-1.57\t-1.17\t1.29\t0.23\t-0.20\t1.17\t0.26
H\t-1.53\t-1.25\t0.59\t-0.30\t0.32\t1.41\t0.77
"""
print "Example numerical matrix"
print matrix
# #Names  col1    col2    col3    col4    col5    col6    col7
# A      -1.23   -0.81    1.79    0.78   -0.42   -0.69    0.58
# B      -1.76   -0.94    1.16    0.36    0.41   -0.35    1.12
# C      -2.19    0.13    0.65   -0.51    0.52    1.04    0.36
```

```
# D      -1.22  -0.98  0.79   -0.76  -0.29  1.54  0.93
# E      -1.47  -0.83  0.85   0.07  -0.81  1.53  0.65
# F      -1.04  -1.11  0.87   -0.14  -0.80  1.74  0.48
# G      -1.57  -1.17  1.29   0.23  -0.20  1.17  0.26
# H      -1.53  -1.25  0.59   -0.30  0.32  1.41  0.77
#
#
# We load a tree structure whose leaf nodes correspond to rows in the
# numerical matrix. We use the text_array argument to link the tree
# with numerical matrix.
t = ClusterTree("((A,B),(C,(D,E))),(F,(G,H)));", text_array=matrix)
t.show("heatmap")
t.show("cluster_cbars")
t.show("cluster_bars")
t.show("cluster_lines")
```

2.4.4 Cluster Validation Example

If associated matrix represents the dataset used to produce a given tree, clustering validation values can be used to assess the quality of partitions. To do so, you will need to set the distance function that was used to calculate distances among items (leaf nodes). ETE implements three common distance methods in bioinformatics : **euclidean**, **pearson** correlation and **spearman** correlation distances.

In the following example, a microarray clustering result is visualized and validated using ETE.

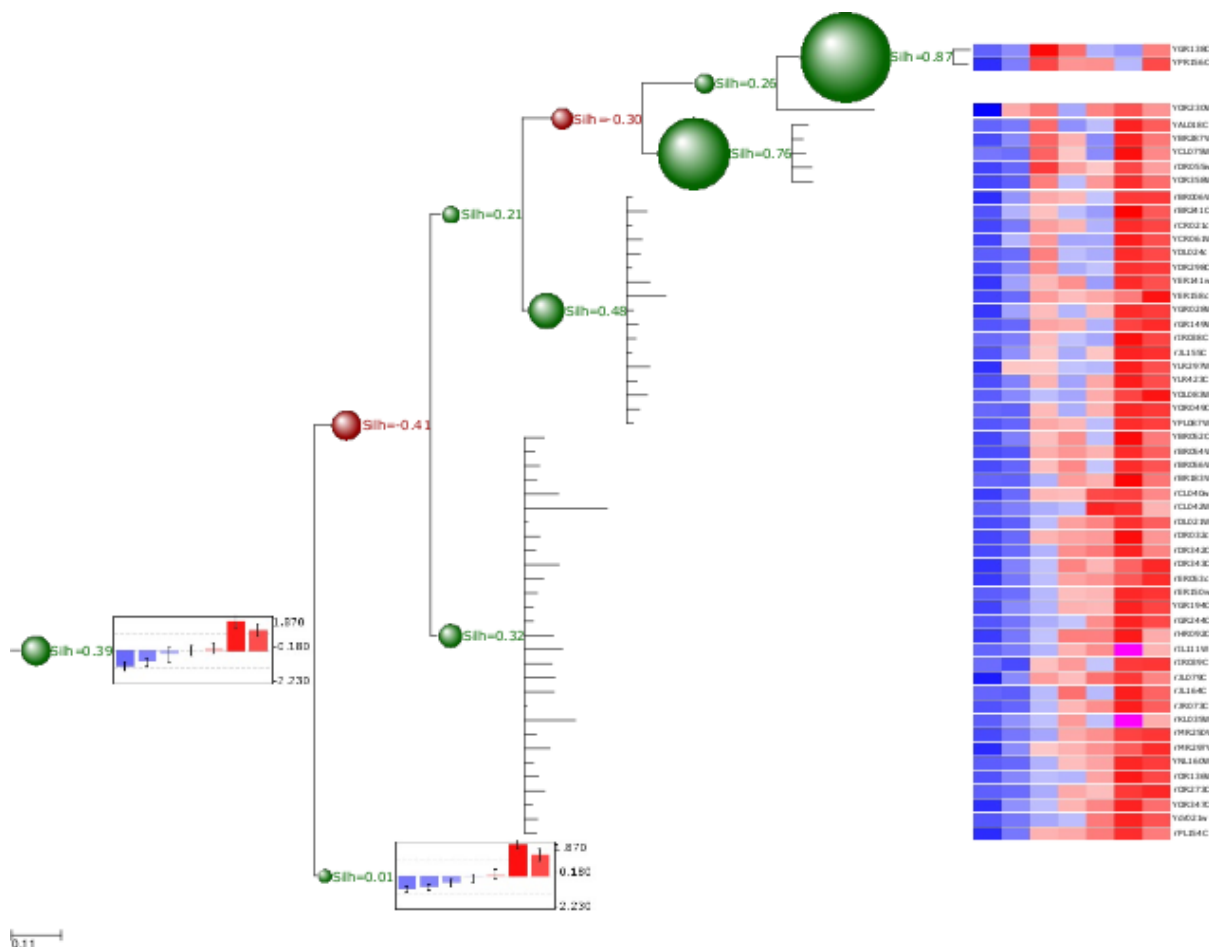

Image resulting from a microarray clustering validation analysis. Red bubbles represent a bad silhouette index ($S < 0$), while green represents good silhouette index ($S > 0$). Size of bubbles is proportional to the Silhouette index. Internal nodes are drawn with the average expression profile grouped by their partitions. Leaf node profiles are shown as a heatmap.

```
from ete2 import ClusterTree, TreeStyle, AttrFace, ProfileFace, TextFace
from ete2.treeview.faces import add_face_to_node

# To operate with numbers efficiently
import numpy

PATH = "./"
# Loads tree and array
t = ClusterTree(PATH+"diauxic.nw", PATH+"diauxic.array")

# nodes are linked to the array table
array = t.arraytable

# Calculates some stats on the matrix. Needed to establish the color
# gradients.
matrix_dist = [i for r in xrange(len(array.matrix))\
                for i in array.matrix[r] if numpy.isfinite(i)]
matrix_max = numpy.max(matrix_dist)
matrix_min = numpy.min(matrix_dist)
matrix_avg = matrix_min+((matrix_max-matrix_min)/2)

# Creates a profile face that will represent node's profile as a
# heatmap
profileFace = ProfileFace(matrix_max, matrix_min, matrix_avg, \
                           200, 14, "heatmap")
cbarsFace = ProfileFace(matrix_max,matrix_min,matrix_avg,200,70,"cbars")
nameFace = AttrFace("name", fsize=8)
# Creates my own layout function that uses previous faces
def mylayout(node):
    # If node is a leaf
    if node.is_leaf():
        # And a line profile
        add_face_to_node(profileFace, node, 0, aligned=True)
        node.img_style["size"]=0
        add_face_to_node(nameFace, node, 1, aligned=True)

    # If node is internal
    else:
        # If silhouette is good, creates a green bubble
        if node.silhouette>0:
            validationFace = TextFace("Silh=%0.2f" %node.silhouette,
                                      "Verdana", 10, "#056600")
            node.img_style["fgcolor"]="#056600"
        # Otherwise, use red bubbles
        else:
            validationFace = TextFace("Silh=%0.2f" %node.silhouette,
                                      "Verdana", 10, "#940000")
            node.img_style["fgcolor"]="#940000"

    # Sets node size proportional to the silhouette value.
    node.img_style["shape"]="sphere"
    if node.silhouette<=1 and node.silhouette>=-1:
        node.img_style["size"]= 15+int((abs(node.silhouette)*10)**2)
```



```

# If node is very internal, draw also a bar diagram
# with the average expression of the partition
add_face_to_node(validationFace, node, 0)
if len(node)>100:
    add_face_to_node(cbarsFace, node, 1)

# Use my layout to visualize the tree
ts = TreeStyle()
ts.layout_fn = mylayout
t.show(tree_style=ts)

```

2.5 Phylogenetic XML standards

New in version 2.1.

From version 2.1, ETE provides support for [NeXML](#) and [PhyloXML](#) phylogenetic XML standards, both reading and writing. These standards allow to encode complex phylogenetic data, and therefore they are not limited to trees. Although ETE is mainly focused on allowing transparent interaction with trees, it also provides basic I/O methods to data of different type.

Essentially, NeXML and PhyloXML files are intended to encode collections of phylogenetic data. Such information can be converted to a collection Python objects sorted in a hierarchical way. A specific Python class exists for every element encoded documented by the NeXML and PhyloXML formats. This is possible thanks to the the general purpose Python drivers available for both formats (<http://etetoolkit.org/phyloxml-and-nexml-python-parsers>). ETE will use such drivers to access XML data, and it will also convert tree data into PhyloTree objects. In practice, conversions will occur transparently. NeXML and PhyloXML files are loaded using their specific root classes, provided by the main ETE module, and all the information will become available as a collection of Python objects internally sorted according to the original XML hierarchy.

New in version 2.1.

2.5.1 NeXML

NeXML(<http://nexml.org>) is an exchange standard for representing phyloinformatic data inspired by the commonly used NEXUS format, but more robust and easier to process.

Reading NeXML projects

Nexml projects are handled through the *Nexml* base class. To load a NexML file, the *Nexml.build_from_file()* method can be used.

```

from ete2 import Nexml

nexml_prj = Nexml()
nexml_prj.build_from_file("/path/to/nexml_example.xml")

```

Note that the ETE parser will read the provided XML file and convert all elements into python instances, which will be hierarchically connected to the Nexml root instance.

Every NeXML XML element has its own python class. Content and attributes can be handled through the “`set_`” and “`get_`” methods existing in all objects. Nexml classes can be imported from the `ete2.nexml` module.

```
from ete2 import Nexml, nexml
nexml_prj = Nexml()
nexml_meta = nexml.LiteralMeta(datatype="double", property="branch_support", content=1.0)
nexml_prj.add_meta(nexml_meta)
nexml_prj.export()

# Will produce:
#
# <Nexml xmlns:xsi="http://www.w3.org/2001/XMLSchema-instance" xsi:type="Nexml">
#   <meta datatype="double" content="1.0" property="branch_support" xmlns:xsi="http://w
# </Nexml>
```

NeXML trees

NeXML tree elements are automatically converted into *PhyloTree* instances, containing all ETE functionality (traversing, drawing, etc) plus normal NeXML attributes.

In the Nexml standard, trees are represented as plain lists of nodes and edges. ETE will convert such lists into tree topologies, in which every node will contain a `nexml_node` and `nexml_edge` attribute. In addition, each tree node will have a `nexml_tree` attribute (i.e. NEXML->FloatTree), which can be used to set the nexml properties of the subtree represented by each node. Note also that `node.dist` and `node.name` features will be linked to `node.nexml_edge.length` and `node.nexml_node.label`, respectively.

```
from ete2 import Nexml
# Create an empty Nexml project
nexml_project = Nexml()

# Load content from NeXML file
nexml_project.build_from_file("trees.xml")

# All XML elements are within the project instance.
# exist in each element to access their attributes.
print "Loaded Taxa:"
for taxa in nexml_project.get_otus():
    for otu in taxa.get_otu():
        print "OTU:", otu.id

# Extracts all the collection of trees in the project
tree_collections = nexml_project.get_trees()
# Select the first collection
collection_1 = tree_collections[0]

# print the topology of every tree
for tree in collection_1.get_tree():
    # trees contain all the nexml information in their "nexml_node",
    # "nexml_tree", and "nexml_edge" attributes.
    print "Tree id", tree.nexml_tree.id
    print tree
    for node in tree.traverse():
        print "node", node.nexml_node.id, "is associated with", node.nexml_node.otu, "OTU"
```

```

# Output:
# =====
# Loaded Taxa:
# OTU: t1
# OTU: t2
# OTU: t3
# OTU: t4
# OTU: t5
# Tree id tree1
#
#           /-n5 (n5)
#          /---|
#         |     \-n6 (n6)
#        /---|
#       |     |     /-n8 (n8)
#      ----|     \---|
#         |         \-n9 (n9)
#         |
#        \-n2 (n2)
# node n1 is associated with None OTU
# node n3 is associated with None OTU
# node n2 is associated with t1 OTU
# node n4 is associated with None OTU
# node n7 is associated with None OTU
# node n5 is associated with t3 OTU
# node n6 is associated with t2 OTU
# node n8 is associated with t5 OTU
# node n9 is associated with t4 OTU
# Tree id tree2
#
#           /-tree2n5 (n5)
#          /---|
#         |     \-tree2n6 (n6)
#        /---|
#       |     |     /-tree2n8 (n8)
#      ----|     \---|
#         |         \-tree2n9 (n9)
#         |
#        \-tree2n2 (n2)
# node tree2n1 is associated with None OTU
# node tree2n3 is associated with None OTU
# node tree2n2 is associated with t1 OTU
# node tree2n4 is associated with None OTU
# node tree2n7 is associated with None OTU
# node tree2n5 is associated with t3 OTU
# node tree2n6 is associated with t2 OTU
# node tree2n8 is associated with t5 OTU
# node tree2n9 is associated with t4 OTU

```

[Download tolweb.xml example] || [Download script]

Node meta information is also available:

```

from ete2 import Nexml

# Creates and empty NeXML project
p = Nexml()
# Fill it with the tolweb example

```

```
p.build_from_file("tolweb.xml")

# extract the first collection of trees
tree_collection = p.trees[0]
# and all the tree instances in it
trees = tree_collection.tree

# For each loaded tree, prints its structure and some of its
# meta-properties
for t in trees:
    print t
    print
    print "Leaf node meta information:\n"
    print
    for meta in t.children[0].nexml_node.meta:
        print meta.property, ":", (meta.content)

# Output
# =====
#
# ---- /-node3(Eurysphindus)
#
# Leaf node meta information:
#
#
# dc:description :
# tbe:AUTHORITY : Leconte
# tbe:AUTHDATE : 1878
# tba:ANCESTORWITHPAGE : 117851
# tba:CHILDCOUNT : 0
# tba:COMBINATION_DATE : null
# tba:CONFIDENCE : 0
# tba:EXTINCT : 0
# tba:HASPAGE : 1
# tba:ID : 117855
# tba:INCOMPLETESUBGROUPS : 0
# tba:IS_NEW_COMBINATION : 0
# tba:ITALICIZENAME : 1
# tba:LEAF : 0
# tba:PHYLESIS : 0
# tba:SHOWAUTHORITY : 0
# tba:SHOWAUTHORITYCONTAINING : 1
```

[Download tolweb.xml example] || [Download script]

Creating Nexml project from scratch *Nexml* base class can also be used to create projects from scratch in a programmatic way. Using the collection of NeXML classes provided by the:mod:ete2.nexml module, you can populate an empty project and export it as XML.

```
import sys
# Note that we import the nexml module rather than the root Nexml
# class. This module contains a python object for each of the
# nexml elements declared in its XML schema.
from ete2 import nexml

# Create an empty Nexml project
```

```
nexml_project = nexml.Nexml()
tree_collection = nexml.Trees()

# NexmlTree is a special PhyloTree instance that is prepared to be
# added to NeXML projects. So lets populate a random tree
nexml_tree = nexml.NexmlTree()
# Random tree with 10 leaves
nexml_tree.populate(10, random_branches=True)
# We add the tree to the collection
tree_collection.add_tree(nexml_tree)

# Create another tree from a newick string
nexml_tree2 = nexml.NexmlTree("((hello, nexml):1.51, project):0.6;")
tree_collection.add_tree(nexml_tree2)

# Tree can be handled as normal ETE objects
nexml_tree2.show()

# Add the collection of trees to the NexML project object
nexml_project.add_trees(tree_collection)

# Now we can export the project containing our two trees
nexml_project.export()
```

[Download script]

Writing NeXML objects Every NexML object has its own `export()` method. By calling it, you can obtain the XML representation of any instance contained in the Nexml project structure. Usually, all you will need is to export the whole project, but individual elements can be exported.

```
import sys
from ete2 import Nexml
# Create an empty Nexml project
nexml_project = Nexml()

# Upload content from file
nexml_project.build_from_file("nexml_example.xml")

# Extract first collection of trees
tree_collection = nexml.get_trees()[0]

# And export it
tree_collection.export(output=sys.stdout, level=0)
```

NeXML tree manipulation and visualization

NeXML trees contain all ETE PhyloTree functionality: orthology prediction, topology manipulation and traversing methods, visualization, etc.

For instance, tree changes performed through the visualization GUI are kept in the NeXML format.

```
from ete2 import nexml
nexml_tree = nexml.NexMLTree("((hello, nexml):1.51, project):0.6;")
tree_collection.add_tree(nexml_tree)
nexml_tree.show()
```

New in version 2.1.

2.5.2 PhyloXML

PhyloXML (<http://www.phyloxml.org/>) is a novel standard used to encode phylogenetic information. In particular, phyloXML is designed to describe phylogenetic trees (or networks) and associated data, such as taxonomic information, gene names and identifiers, branch lengths, support values, and gene duplication and speciation events.

Loading PhyloXML projects from files

ETE provides full support for phyloXML projects through the *Phyloxml* object. Phylogenies are integrated as ETE's tree data structures as *PhyloxmlTree* instances, while the rest of features are represented as simple classes (*ete2.phyloxml*) providing basic reading and writing operations.

```
from ete2 import Phyloxml
project = Phyloxml()
project.build_from_file("apaf.xml")

# Each tree contains the same methods as a PhyloTree object
for tree in project.get_phylogeny():
    print tree
    # you can even use rendering options
    tree.show()
    # PhyloXML features are stored in the phyloxml_clade attribute
    for node in tree:
        print "Node name:", node.name
        for seq in node.phyloxml_clade.get_sequence():
            for domain in seq.domain_architecture.get_domain():
                domain_data = [domain.valueOf_, domain.get_from(), domain.get_to()]
                print "  Domain:", '\t'.join(map(str, domain_data))
```

[Download script] [Download example]

Each tree node contains two phyloxml elements, *phyloxml_clade* and *phyloxml_phylogeny*. The first attribute contains clade information referred to the node, while *phyloxml_phylogeny* contains general data about the subtree defined by each node. This way, you can split, or copy any part of a tree and it will be exported as a separate phyloxml phylogeny instance.

Note that *node.dist*, *node.support* and *node.name* features are linked to *node.phyloxml_clade.branch_length*, *node.phyloxml_clade.confidence* and *node.phyloxml_clade.name*, respectively.

Creating PhyloXML projects from scratch

In order to create new PhyloXML projects, a set of classes is available in the *ete2.phyloxml* module.

```
from ete2 import Phyloxml, phyloxml
import random
project = Phyloxml()

# Creates a random tree
phylo = phyloxml.PhyloxmlTree()
phylo.populate(5, random_branches=True)
```

```

phylo.phyloxml_phylogeny.set_name("test_tree")
# Add the tree to the phyloxml project
project.add_phylogeny(phylo)

print project.get_phylogeny()[0]

#           /-iajom
#        /---|
#       |     \-wisch
#-----|
#       |     /-xrygw
#        \---|
#           |     /-gjlwx
#           \---|
#              \-ijvnk

# Trees can be operated as normal ETE trees
phylo.show()

# Export the project as phyloXML format
project.export()

# <phy:Phyloxml xmlns:phy="http://www.phyloxml.org/1.10/phyloxml.xsd">
#   <phy:phylogeny>
#     <phy:name>test_tree</phy:name>
#     <phy:clade>
#       <phy:name>NoName</phy:name>
#       <phy:branch_length>0.000000e+00</phy:branch_length>
#       <phy:confidence type="branch_support">1.0</phy:confidence>
#     <phy:clade>
#       <phy:name>NoName</phy:name>
#       <phy:branch_length>1.665083e-01</phy:branch_length>
#       <phy:confidence type="branch_support">0.938507980435</phy:confidence>
#     <phy:clade>
#       <phy:name>NoName</phy:name>
#       <phy:branch_length>1.366655e-01</phy:branch_length>
#       <phy:confidence type="branch_support">0.791888248212</phy:confidence>
#     <phy:clade>
#       <phy:name>ojnfg</phy:name>
#       <phy:branch_length>2.194209e-01</phy:branch_length>
#       <phy:confidence type="branch_support">0.304705977822</phy:confidence>
#     </phy:clade>
#     <phy:clade>
#       <phy:name>qrfnz</phy:name>
#       <phy:branch_length>5.235437e-02</phy:branch_length>
#       <phy:confidence type="branch_support">0.508533765418</phy:confidence>
#     </phy:clade>
#   </phy:clade>
#   <phy:clade>
#     <phy:name>shngq</phy:name>
#     <phy:branch_length>9.740958e-01</phy:branch_length>
#     <phy:confidence type="branch_support">0.642187390965</phy:confidence>
#   </phy:clade>
#   <phy:clade>
#     <phy:name>NoName</phy:name>

```

```
#           <phy:branch_length>3.806412e-01</phy:branch_length>
#           <phy:confidence type="branch_support">0.383619811911</phy:confidence>
#           <phy:clade>
#               <phy:name>vfmnk</phy:name>
#               <phy:branch_length>6.495163e-01</phy:branch_length>
#               <phy:confidence type="branch_support">0.141298879514</phy:confidence>
#           </phy:clade>
#           <phy:clade>
#               <phy:name>btexi</phy:name>
#               <phy:branch_length>5.704955e-01</phy:branch_length>
#               <phy:confidence type="branch_support">0.951876078012</phy:confidence>
#           </phy:clade>
#       </phy:clade>
#   </phy:phylogeny>
# </phy:Phyloxml>
```

[Download script]

Note: NeXML and PhyloXML python parsers are possible thanks to Dave Kuhlman and his work on the `generateDS.py` application. Thanks Dave! ;-)

New in version 2.1.

2.6 Interactive web tree visualization

Starting at version 2.1, ETE provides a module to interactively display trees within web pages. This task is not straightforward, but ETE tries to simplify it by providing a basic `WebTreeApplication` class that can be imported in your python web applications.

`WebTreeApplication` implements a transparent connector between ETE's functionality and web application. For this, a pre-built `WSGI` application is provided.

Through this application, you will be able to create custom web implementations to visualize and manipulate trees interactively. Some examples can be found at the [PhylomeDB tree browser](#) or in the [ETE's online treeviewer](#).

2.6.1 NO X system available?

Alternatively, a virtual X system such as `XVFB` has been reported to work in servers without a proper X backend. Just install `XVFB` and preface your ETE commands with `xvfb-run`.

```
xvfb-run python MyETEScript.py
```

2.6.2 Installing a X server

All modern linux desktop installations include a graphical interface (called X server). However web servers (in which the ETE plugin is expected to run) may not count with a X server.

2.6.3 Servers

In order to render tree images with ETE, you will need to install, at least, a basic X server. Note that the X server does not require a desktop interface, such as Gnome or KDE.

In Ubuntu, for instance, a basic X server called `xdm` can be installed as follows:

```
apt-get install xserver-xorg xdm xfonts-base xfonts-100dpi
xfonts-75dpi
```

Once the X server is installed, you will need to configure it to accept connections from the web-server.

In our example, edit the `/etc/X11/xdm/xdm-config` file and set following values:

```
DisplayManager*authorize:      false
!
DisplayManager*authComplain:  false
```

Do not forget to restart your `xdm` server.

```
/etc/init.d/xdm restart
```

2.6.4 Desktops

If you plan to use web tree application in a linux desktop computer, then the X server is already installed. You will only need to give permissions to the web-server (i.e. apache) to connect your display. Usually, as simple as running the following command in a terminal:

```
xhost +
```

2.6.5 Configuring the web sever

You will need to add support for WSGI application to your web server. In the following steps, an Apache2 web server will be assumed.

- Install and activate the `modwsgi` module in Apache.
- Configure your site to support WSGI.

Configuration will depend a lot on your specific system, but this is an example configuration file for the default site of your Apache server (usually at `/etc/apache2/sites-available/default`):

```
<VirtualHost *:80>
  ServerAdmin webmaster@localhost

  DocumentRoot /var/www
  <Directory />
    Options +FollowSymLinks
    AllowOverride None
  </Directory>

  ErrorLog /var/log/apache2/error.log

  # Possible values include: debug, info, notice, warn, error, crit,
  # alert, emerg.
  LogLevel warn
```

```
CustomLog /var/log/apache2/access.log combined

# ##### #
# WSGI SPECIFIC CONFIG #

WSGIDaemonProcess eteApp user=www-data group=www-data processes=1 threads=1
WSGIProcessGroup eteApp
WSGIApplicationGroup %{GLOBAL}

<Directory /var/www/webplugin/>
    Options +ExecCGI -MultiViews +SymLinksIfOwnerMatch
    SetHandler wsgi-script
    Order allow,deny
    Allow from all
    AddHandler wsgi-script .py
</Directory>

# END OF WSGI SPECIFIC CONFIG #
# ##### #

</VirtualHost>
```

Note: */var/www/webplugin/wsgi/* is the folder in which python web application will be located. Make sure that the apache WSGI config enables this folder to run wsgi-scripts.

Warning: Important notes:

/var/www/webplugin/ is assumed to be the directory in which your application will run.
/var/www/webplugin/tmp/ should be writable by the web-server (i.e. `chmod 777`)

2.6.6 Implementation of WebTreeApplications

ETE's *WebTreeApplication* uses WSGI in the backend, and a several javascript files in the frontend. Basic files are included as an example in the [ETE installation package](#) `examples/webplugin`. The whole example folder is necessary, and it contains a commented copy of a web-tree implementation `examples/webplugin/wsgi/webplugin_example.py`.

2.7 Testing Evolutionary Hypothesis

Contents

- *Testing Evolutionary Hypothesis*
 - *Extension Requirements:*
 - *Overview*
 - * *The working directory*
 - *Descriptive analysis*
 - * *Branch model*
 - * *Site model*
 - *Hypothesis Testing*
 - * *Test on sites*
 - * *Test on branches*
 - * *Test on branch-sites*
 - *Utilities*
 - * *Load precomputed evolutionary model*
 - *References*

2.7.1 Extension Requirements:

You should have codeml and slr in your path:

- CodeML, you can download it from <http://abacus.gene.ucl.ac.uk/software/paml.html>
- SLR, from here: <http://www.ebi.ac.uk/goldman-srv/SLR/>

Download, compile and install both of the programs, in order to be able to run the examples.

This ETE extension is written on top of these two external programs, so it is strongly recommended to read their corresponding documentation.

2.7.2 Overview

An other aspect in the study of evolutionary history, is the analysis of selective pressures accounting for the conservation or degeneration of **protein coding genes**.

The *EvoTree* class is an extension of the class *PhyloTree* that implements mainly bindings to the PAML package [yang2007] but also to the SLR program [massingham2005].

Evolutionary variables that are used to summary selective pressures are, of course the branch-length (*bL*) already available in *PhyloTree*, but also the rate of non-synonymous mutations (*dN*), the rate of synonymous mutations (*dS*) and finally the ω ratio:

$$\omega = \frac{dN}{dS} \quad (2.1)$$

The working directory

EvoTree works mainly as PhyloTree, thus it needs a tree and an alignment. However as you are going to run external programs over it, **a working directory needs to be defined**. By default tree.workdiris “/tmp/ete2-codeml/”, but it is recommended to change it to a more useful path.

Jobs will be stored in the workdir, and you will be able to load precomputed evolutionary models from there.

2.7.3 Descriptive analysis

In order to identify the evolutionary trends in a phylogenetic tree, one can either:

- conduct an analysis over branches and compute the value of ω in each of them.
- look at the selective pressures along the alignment.

Branch model

As for *PhyloTree*, we first load the tree and alignment (and you working directory, if you want to save a copy of your jobs):

```
from ete2 import EvolTree

tree = EvolTree("((Hylobates_lar, (Gorilla_gorilla, Pan_troglodytes)), Papio_cynocephalus);

tree.link_to_alignment ('>Hylobates_lar
ATGGCCAGGTACAGATGCTGCCGAGCCAGAGCCGGAGCAGATGTTACCGCCAGAGCCGGAGCAGATGTTACCGCCAGAGGCAAAGCC
>Papio_cynocephalus
ATGGCCAGGTACAGATGCTGCCGAGCCAGAGCCGAAGCAGATGCTATCGCCAGAGCCGGAGCAGATGTAACCGCCAGAGACAGAGCC
>Gorilla_gorilla
ATGGCCAGGTACAGATGCTGTCGAGCCAGAGCCGAGCAGATGTTACCGGCAGAGCCGGAGCAGGTGTTACCGGCAGAGACAAAGCC
>Pan_troglodytes
ATGGCCAGGTACAGATGCTGTCGAGCCAGAGCCGGAGCAGATGTTACCGGCAGAGACGGAGCAGGTGTTACCGGCAGAGGCAAAGCC

tree.workdir = '/path_to/my_working_directory/'
```

Once loaded we are able to compute selective pressure among the tree according to an evolutionary model. In this case, we will use free-ratio model:

```
tree.run_model ('fb.example')
```

EvolNode.run_model() allows to run different evolutionary models (follow this link [EvolNode.run_model\(\)](#) to see the full list of models available). By convention, the name of the model called is the first word, the rest of the string, after the dot, corresponds to its identifier in order to differentiate different runs of one model. We can thus either run “fb” model and “fb.something” with the same result, but they will be stored under different names instead of being overwritten.

Once computation is done, we can retrieve the *evol.Model* object from the tree, with the *EvolNode.get_evol_model()* function.

```
my_first_fb_model = tree.get_evol_model('fb.example')

print my_first_fb_model
```

This last print statement would output:

```
Evolutionary Model fb.example:
  log likelihood      : -521.421323
  number of parameters : 13
  sites inference     : None
  sites classes       : None
  branches            :
  mark: #0 , omega: None      , node_ids: 5 , name: NoName
  mark: #1 , omega: 0.0001    , node_ids: 6 , name: NoName
  mark: #2 , omega: 999.0     , node_ids: 4 , name: Papio_cynocephalus
```

```
mark: #3 , omega: 999.0      , node_ids: 2  , name: Hylobates_lar
mark: #4 , omega: 0.0001    , node_ids: 7  , name: NoName
mark: #5 , omega: 0.1049    , node_ids: 1  , name: Gorilla_gorilla
mark: #6 , omega: 0.5334    , node_ids: 3  , name: Pan_troglodytes
```

By default, the free-branch model is run with this parameters:

```
print my_first_fb_model.get_ctrl_string()

#      seqfile = algn
#      treefile = tree
#      outfile = out
#
#      aaDist = 0
#      fix_alpha = 1
#      alpha = 0.0
#      fix_blength = 0
#      cleandata = 0
#      clock = 0
#      CodonFreq = 2
#      getSE = 0
#      icode = 0
#      fix_kappa = 0
#      kappa = 2
#      Malpha = 0
#      method = 0
#      Mgene = 0
#      model = 1
#      ncatG = 8
#      noisy = 0
#      NSsites = 0
#      fix_omega = 0
#      omega = 0.7
#      RateAncestor = 0
#      runmode = 0
#      seqtype = 1
#      Small_Diff = 1e-6
#      verbose = 2
```

However, it is usually recommended to run one model several times with different starting values, and keep only the model with higher likelihood. Here an example, on how to do this.

```
best_model = None
best_lnl = float('-inf')
for starting_omega in [0.2, 0.7, 1.2]:
    tree.run_model('fb.'+str(starting_omega))
    current_model = tree.get_evol_model('fb.'+str(starting_omega))
    print 'current model log likelihood:', current_model.lnL
    if current_model.lnL > best_lnl:
        best_lnl = current_model.lnL
        best_model = current_model
```

Finally in order to have a quick look of the selctive pressures over our phylogeny:

```
tree.show()
```

by default this will the picture obtained:

Node size, and color dependant of the ω value. But other displays are available:

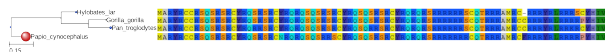

```
from ete2.treeview.layouts import evol_clean_layout

tree.show(layout=evol_clean_layout)
```

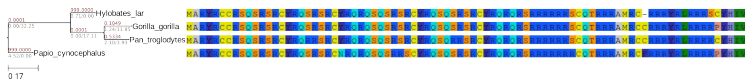

With here ω ratios in red and also in gray the dN and dS values.

Site model

Another way to look at selective pressures, is to compute directly along the alignment, the value of ω for a whole column (putting all leaves together). For doing this, we can use for example the model M2 of CodeML or directly use SLR. As before we just have to:

```
tree.run_model('M2')
tree.run_model('SLR.lele')
```

and to display the results:

```
tree.show(histfaces=['M2'])
```

when a site model is computed, an histface is automatically generated. Thus with this call, what we are doing is to draw the default histface corresponding to the model named M2.lala. This is the result:

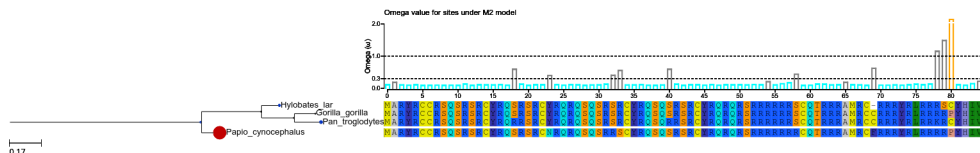

However customizing this face is feasible:

```
model2 = tree.get_evolutionary_model('M2')

col2 = {'NS': 'black', 'RX': 'black',
        'RX+': 'black', 'CN': 'black',
        'CN+': 'black', 'PS': 'black', 'PS+': 'black'}

model2.set_histface(up=False, kind='curve', colors=col2, ylim=[0,4], hlines = [2.5, 1.0])

tree.show(histfaces=['M2'])
```

or:

```
col = {'NS': 'grey', 'RX': 'black',
        'RX+': 'grey', 'CN': 'black',
        'CN+': 'grey', 'PS': 'black', 'PS+': 'black'}

model2.set_histface(up=False, kind='stick', hlines = [1.0,0.3], hlines_col=['black','grey'])

tree.show(histfaces=['M2'])
```

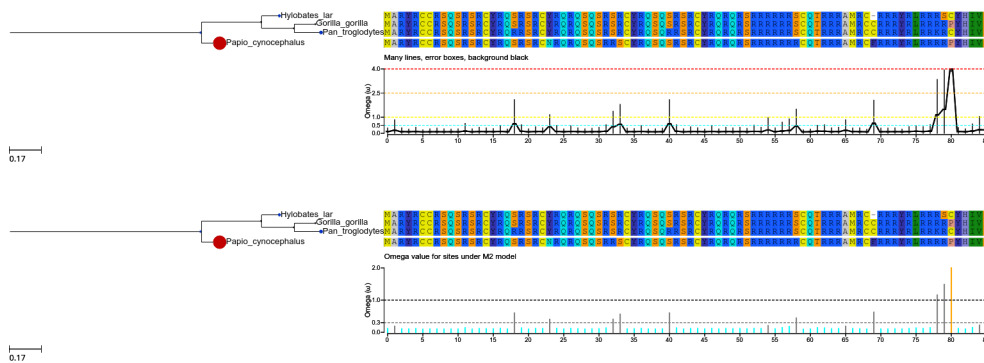

The col dictionary contains the colors for sites detected to be under positive selection (PS), relaxation (RX), or conserved (CN). However, it is not a good idea to use them now as we do not know if there is indeed positive selection.

To be able to accept M2 results we will have to test this model against a null model.

2.7.4 Hypothesis Testing

In order to know if the parameters estimated under a given model are reliable, we have to compare its likelihood to a null model.

Usually, the alternative model is a model that estimates the proportion of sites with $\omega > 1$ and we compare its likelihood with a null model, usually a model that does not (letting $\omega \leq 1$). This comparison is done through a likelihood ratio test. If the alternative model has the best fit then we are able to accept the possibility of $\omega > 1$.

To see a non-exhaustive list of famous comparisons see the documentation of the function: `EvolNode.get_most_likely()`

Test on sites

In order to know if some sites are significantly under positive selection, relaxed or conserved we have usually to compare 2 models. However using the model “SLR” we can directly infer positive selection or relaxation through the SLR program [massingham2005].

The most usual comparison, and perhaps the most robust, is the comparison of models M2 and M1.

```
tree.run_model ('M1')
tree.run_model ('M2')

pval = tree.get_most_likely ('M2', 'M1')

model2 = tree.get_evolution_model('M2')

print model2

# Evolutionary Model M2:
#   log likelihood      : -517.824749
#   number of parameters : 11
#   sites inference     : BEB, NEB
#   sites classes       :
#   proportions: p0=0.98794  p1=0.00000  p2=0.01206
```

```
#           w           : w0=0.09887   w1=1.00000   w2=178.86153
#           branches           :
#           mark: #0, omega: 2.25526440485   , nodes paml_ids: 6 4 2 7 1 3

if pval < 0.05:
    print 'M2 model wins.'
    for s in range(len(model2.sites['BEB']['aa'])):
        if model2.sites['BEB']['p2'][s] > 0.95:
            print 'positively selected site %s at position: %s, with probability: %s' % (model2.sites['BEB']['aa'][s], s, model2.sites['BEB']['p2'][s])
else:
    print 'M1 model is not rejected'

# M2 model wins.
# positively selected site P at position: 81, with probability: 0.96293
```

Each sites model, contains a dictionary ‘model.sites’ in which are stored the results of CodeML. These are displayed through the histface, but they are still accessible by digging a bit. ‘site’ dictionary usually contains the result of the NEB and BEB analysis (prefer the BEB when available). For each of BEB and NEB, the probability of belonging from one category of site is summarized by ‘p0’, ‘p1’ and ‘p2’ in the case of M2 model that have only 3 class of sites (p0, the probability of belonging to the first class of sites with $\omega < 1$; p1, the probability of belonging to the second class of sites with $\omega = 1$; p2, the probability of belonging to the third class of sites with $\omega > 1$). *For details on the models and outputs, it is recommended to read PAML documentation.*

Test on branches

CodeML allows to test models that infer different selective pressures on a set of given branches. To do it, some branches of the tree are marked (usually with strings like this: ‘#1’). This is how to do it with ETE:

```
marks = ['2', '3', '4']

# mark a group of branches
tree.mark_tree (marks, ['#1', '#1', '#1'])
print tree.write ()

# ((Hylobates_lar, (Gorilla_gorilla #1, Pan_troglodytes #1) #1), Papio_cynocephalus);
```

By doing this a branch model will compute different ω values in mark branches (usually called foreground ω_{frg}) and in the rest of the tree (usually called background ω_{bkg}).

Two kinds of branch models are usually used:

- the free-branch model: were ω_{frg} and ω_{bkg} are free
- the neutral-branch model: were ω_{frg} is fixed to one.
- the M0 model: were all branches evolve at the same rate.

The comparison between free-branch and M0, will tell us if foreground branches have an ω significantly different from the rest of the tree.

And the comparison between free-branch and neutral-branch models will tell us if ω_{frg} is significantly higher than 1.

```
tree.run_model ('b_free')
tree.run_model ('b_neut')
```



```

tree.run_model ('M0')

b_free = tree.get_evol_model('b_free')

print b_free

# Evolutionary Model b_free.234:
#   log likelihood      : -525.690213
#   number of parameters : 9
#   sites inference     : None
#   sites classes       : None
#   branches            :
#   mark: #0, omega: 0.157280451975 , nodes paml_ids: 6 4 2
#   mark: #1, omega: 0.118462858241 , nodes paml_ids: 7 1 3

if tree.get_most_likely ('b_free', 'M0') < 0.05:
    # branch models have a branches dictionary where keys corresponds to paml_id of nodes
    # select one of the marked branches
    frg_node = tree.search_nodes(_nid=2)[0]
    frg_pamlid = frg_node.paml_id
    w_frg = bfree.branches[frg_pamlid]['w']
    # select one of the unmarked branches
    bkg_node = tree.search_nodes(_nid=1)[0]
    bkg_pamlid = bkg_node.paml_id
    w_bkg = bfree.branches[bkg_pamlid]['w']
    print 'foreground branches evolving at omega value of %s significantly different from %s' % (w_frg, w_bkg)

if tree.get_most_likely ('b_free', 'b_neut') < 0.05:
    print 'foreground branches are significantly different from 1.'

```

for the given example, background and foreground are not different...

Test on branch-sites

An other popular test is the branch-site test contrasting model A and A1. This test allows to detect genes with some sites under positive selection.

this example shows how to run it over all branches in the tree:

```

# also needs the M0 model as null model
tree.run_model ('M0')

for leaf in tree:
    leaf.node_id
    print '\n-----\nNow working with leaf ' + leaf.name
    tree.mark_tree ([leaf.node_id], marks=['#1'])
    print tree.write()
    # to organize a bit, we name model with the name of the marked node
    # any character after the dot, in model name, is not taken into account
    # for computation. (have a look in /tmp/ete2.../bsA.. directory)
    print 'running model bsA and bsA1'
    tree.run_model ('bsA.' + leaf.name)
    tree.run_model ('bsA1.' + leaf.name)
    print 'p-value of positive selection for sites on this branch is: '
    ps = tree.get_most_likely ('bsA.' + leaf.name, 'bsA1.' + leaf.name)
    rx = tree.get_most_likely ('bsA1.' + leaf.name, 'M0')

```

```

print str (ps)
print 'p-value of relaxation for sites on this branch is: '
print str (rx)
if ps<0.05 and float (bsA.wfrg2a)>1:
    print 'we have positive selection on sites on this branch'
elif rx<0.05 and ps>=0.05:
    print 'we have relaxation on sites on this branch'
else:
    print 'no signal detected on this branch, best fit for M0'
print '\nclean tree, remove marks'
tree.mark_tree (map (lambda x: x.node_id, tree.get_descendants()),
                marks=[''] * len (tree.get_descendants()), verbose=True)

print tree.get_evol_model('bsA.Hylobates_lar')

# Evolutionary Model bsA.Hylobates_lar:
#   log likelihood      : -521.203318
#   number of parameters : 11
#   sites inference    : BEB, NEB
#   sites classes      :
#   foreground w: f0=0.06452   f1=1.00000   f2=3.15727   f3=3.15727
#   proportions : p0=0.00415   p1=0.00023   p2=0.94413   p3=0.05150
#   background w: b0=0.06452   b1=1.00000   b2=0.06452   b3=1.00000
#   branches          :
#   mark: #0 , omega: None      , node_ids: 5 , name: NoName
#   mark: #0 , omega: None      , node_ids: 6 , name: NoName
#   mark: #0 , omega: None      , node_ids: 4 , name: Papio_cynocephalus
#   mark: #1 , omega: None      , node_ids: 2 , name: Hylobates_lar
#   mark: #0 , omega: None      , node_ids: 7 , name: NoName
#   mark: #0 , omega: None      , node_ids: 1 , name: Gorilla_gorilla
#   mark: #0 , omega: None      , node_ids: 3 , name: Pan_troglodytes

```

2.7.5 Utilities

Load precomputed evolutionary model

When an evolutionary model is computed, the output is stored in *tree.workdir* and can be load afterwards. Inside *tree.workdir*, a new directory is created for each model you compute (if each model has a different name), thus to load one model:

```

from ete2 import EvolTree

tree = EvolTree("((Hylobates_lar,(Gorilla_gorilla,Pan_troglodytes)),Papio_cynocephalus);

tree.link_to_alignment ('>Hylobates_lar
ATGGCCAGGTACAGATGCTGCCGAGCCAGAGCCGGAGCAGATGTTACCGCCAGAGCCGGAGCAGATGTTACCGCCAGAGGCAAAGCC
>Papio_cynocephalus
ATGGCCAGGTACAGATGCTGCCGAGCCAGAGCCGAAGCAGATGCTATCGCCAGAGCCGGAGCAGATGTAACCGCCAGAGACAGAGCC
>Gorilla_gorilla
ATGGCCAGGTACAGATGCTGTCGAGCCAGAGCCGCAGCAGATGTTACCGGCAGAGCCGGAGCAGGTGTTACCGGCAGAGACAAAGCC
>Pan_troglodytes
ATGGCCAGGTACAGATGCTGTCGAGCCAGAGCCGGAGCAGATGTTACCGGCAGAGACGGAGCAGGTGTTACCGGCAAAGGCAAAGCC
tree.link_to_evol_model('/path_to/my_working_directory/fb.example/out', 'fb')

```

Note: *EvolNode.link_to_evol_model()* is also able to load directly *evol.Model* objects.

Indeed all output files generated do not need to be kept, only a `pickle` or `cPickle` of the model for example.

Thus we can save a tree with all Models computed, after having run some models:

```
# assume we already have run some models:
for model in tree._models:
    print tree.get_evol_model(model)

# Evolutionary Model M2.example:
#     log likelihood      : -517.824749
#     number of parameters : 11
#     sites inference     : BEB, NEB
#     sites classes      :
#     proportions : p0=0.98794   p1=0.00000   p2=0.01206
#     w           : w0=0.09887   w1=1.00000   w2=178.86192
#     branches      :
#     mark: #0, omega: 2.25526864047 , nodes paml_ids: 6 4 2 7 1 3
#
# Evolutionary Model M1.example:
#     log likelihood      : -521.541845
#     number of parameters : 9
#     sites inference     : NEB
#     sites classes      :
#     proportions : p0=0.94075   p1=0.05925
#     w           : w0=0.07025   w1=1.00000
#     branches      :
#     mark: #0, omega: 0.125334579074 , nodes paml_ids: 6 4 2 7 1 3

# we save the whole tree into my_tree.pik
from cPickle import dump

out = open('my_tree.pik', 'w')
dump (tree, out)
out.close()
```

and load them:

```
from cPickle import load

out = open('my_tree.pik')
tree = load(out)
out.close()

# and here the same result
for model in tree._models:
    print tree.get_evol_model(model)

# Evolutionary Model M2.example:
#     log likelihood      : -517.824749
#     number of parameters : 11
#     sites inference     : BEB, NEB
#     sites classes      :
#     proportions : p0=0.98794   p1=0.00000   p2=0.01206
#     w           : w0=0.09887   w1=1.00000   w2=178.86192
#     branches      :
#     mark: #0, omega: 2.25526864047 , nodes paml_ids: 6 4 2 7 1 3
#
# Evolutionary Model M1.example:
```

```
#      log likelihood      : -521.541845
#      number of parameters : 9
#      sites inference      : NEB
#      sites classes       :
#      proportions : p0=0.94075   p1=0.05925
#      w           : w0=0.07025   w1=1.00000
#      branches      :
#      mark: #0, omega: 0.125334579074 , nodes paml_ids: 6 4 2 7 1 3
```

this also can be done for one model alone:

```
from cPickle import dump, load

m2_to_save = tree.get_evol_model('M2.example')

out = open('m2.pik', 'w')
dump(m2_to_save, out)
out.close()

# and then load it
out = open('m2.pik')
m2_to_save = dump(out)
out.close()

tree.link_to_evol_model(m2_to_save)
```

2.7.6 References

New in version 2.3.

2.8 Dealing with the NCBI Taxonomy database

ETE's *ncbi_taxonomy* module provides utilities to efficiently query a local copy of the NCBI Taxonomy database. The class *NCBITaxa* offers methods to convert from taxid to names (and vice versa), to fetch pruned topologies connecting a given set of species, or to download rank, names and lineage track information.

It is also fully integrated with *PhyloTree* instances through the *PhyloNode.annotate_ncbi_taxa()* method.

2.8.1 Setting up a local copy of the NCBI taxonomy database

The first time you attempt to use *NCBITaxa*, ETE will detect that your local database is empty and it will attempt to download the latest NCBI taxonomy database (~300MB) and will store a parsed version of it in your home directory: *~/etetoolkit/taxa.sqlite*. All future imports of *NCBITaxa* will detect the local database and will skip this step.

```
from ete2 import NCBITaxa
ncbi = NCBITaxa()
```

2.8.2 Upgrading the local database

Use the method `:NCBITaxa:‘update_taxonomy_database’` to download and parse the latest database from the NCBI ftp site. Your current local database will be overwritten.

```
from ete2 import NCBITaxa
ncbi = NCBITaxa()
ncbi.update_taxonomy_database()
```

2.8.3 Getting taxid information

you can fetch species names, ranks and lineage track information for your taxids using the following methods:

- `NCBITaxa.get_rank()`
- `NCBITaxa.get_lineage()`
- `NCBITaxa.get_taxid_translator()`
- `NCBITaxa.get_name_translator()`
- `NCBITaxa.translate_to_names()`

The so called get-translator-functions will return a dictionary converting between taxids and species names. Either species or lineage names/taxids are accepted as input.

```
from ete2 import NCBITaxa
ncbi = NCBITaxa()
taxid2name = ncbi.get_taxid_translator([9606, 9443])
print taxid2name
# {9443: u'Primates', 9606: u'Homo sapiens'}

name2taxid = ncbi.get_name_translator(["Homo sapiens", "primates"])
print name2taxid
# {'Homo sapiens': 9606, 'primates': 9443}
```

Other functions allow to extract further information using taxid numbers as a query.

```
from ete2 import NCBITaxa
ncbi = NCBITaxa()

print ncbi.get_rank([9606, 9443])
# {9443: u'order', 9606: u'species'}

print ncbi.get_lineage(9606)

# [1, 131567, 2759, 33154, 33208, 6072, 33213, 33511, 7711, 89593, 7742,
# 7776, 117570, 117571, 8287, 1338369, 32523, 32524, 40674, 32525, 9347,
# 1437010, 314146, 9443, 376913, 314293, 9526, 314295, 9604, 207598, 9605,
# 9606]
```

And you can combine combine all at once:

```
from ete2 import NCBITaxa
ncbi = NCBITaxa()

lineage = ncbi.get_lineage(9606)
```

```
print lineage

# [1, 131567, 2759, 33154, 33208, 6072, 33213, 33511, 7711, 89593, 7742,
# 7776, 117570, 117571, 8287, 1338369, 32523, 32524, 40674, 32525, 9347,
# 1437010, 314146, 9443, 376913, 314293, 9526, 314295, 9604, 207598, 9605,
# 9606]

names = ncbi.get_taxid_translator(lineage)
print [names[taxid] for taxid in lineage]

# [u'root', u'cellular organisms', u'Eukaryota', u'Opisthokonta', u'Metazoa',
# u'Eumetazoa', u'Bilateria', u'Deuterostomia', u'Chordata', u'Craniata',
# u'Vertebrata', u'Gnathostomata', u'Teleostomi', u'Euteleostomi',
# u'Sarcopterygii', u'Dipnotetrapodomorpha', u'Tetrapoda', u'Amniota',
# u'Mammalia', u'Theria', u'Eutheria', u'Boreoeutheria', u'Euarchontoglires',
# u'Primates', u'Haplorrhini', u'Simiiiformes', u'Catarrhini', u'Hominoidea',
# u'Hominidae', u'Homininae', u'Homo', u'Homo sapiens']
```

2.8.4 Getting descendant taxa

Given a taxid or a taxa name from an internal node in the NCBI taxonomy tree, their descendants can be retrieved as follows:

```
from ete2 import NCBITaxa
ncbi = NCBITaxa()

descendants = ncbi.get_descendant_taxa('Homo')
print ncbi.translate_to_names(descendants)

# [u'Homo heidelbergensis', u'Homo sapiens ssp. Denisova', u'Homo sapiens neanderthalensis']

# you can easily ignore subspecies, so only taxa labeled as "species" will be reported:
descendants = ncbi.get_descendant_taxa('Homo', collapse_subspecies=True)
print ncbi.translate_to_names(descendants)

# [u'Homo sapiens', u'Homo heidelbergensis']

# or even returned as an annotated tree
tree = ncbi.get_descendant_taxa('Homo', collapse_subspecies=True, return_tree=True)
print tree.get_ascii(attributes=['sci_name', 'taxid'])

#           /-Homo sapiens, 9606
# -Homo, 9605
#         \-Homo heidelbergensis, 1425170
```

2.8.5 Getting NCBI species tree topology

Getting the NCBI taxonomy tree for a given set of species is one of the most useful ways to get all information at once. The method `NCBITaxa.get_topology()` allows to query your local NCBI database and extract the smallest tree that connects all your query taxids. It returns a normal ETE tree in which all nodes, internal or leaves, are annotated for lineage, scientific names, ranks, and so on.

```
from ete2 import NCBITaxa
ncbi = NCBITaxa()
```

```
tree = ncbi.get_topology([9606, 9598, 10090, 7707, 8782])
print tree.get_ascii(attributes=["sci_name", "rank"])

#           /-Dendrochirotida, order
#           |
#           |
# -Deuterostomia, no rank           /Homininae, subfamily
#           |           /Euarchontoglires, superorder
#           |           |
#           \Amniota, no rank           \-Mus musculus, species
#           |
#           \-Aves, class
```

If needed, all intermediate nodes connecting the species can also be kept in the tree:

```
from ete2 import NCBITaxa
ncbi = NCBITaxa()

tree = ncbi.get_topology([2, 33208], intermediate_nodes=True)
print tree.get_ascii(attributes=["sci_name"])

#           /Eukaryota - Opisthokonta - Metazoa
# -cellular organisms
#           \-Bacteria
```

2.8.6 Automatic tree annotation using NCBI taxonomy

NCBI taxonomy annotation consists of adding additional information to any internal a leaf node in a give user tree. Only an attribute containing the taxid associated to each node is required for the nodes in the query tree. The annotation process will add the following features to the nodes:

- sci_name
- taxid
- named_lineage
- lineage
- rank

Note that, for internal nodes, taxid can be automatically inferred based on their sibling nodes. The easiest way to annotate a tree is to use a *PhyloTree* instance where the species name attribute is transparently used as the taxid attribute. Note that the **:PhyloNode:‘annotate_ncbi_taxa‘**: function will also return the used name, lineage and rank translators.

Remember that species names in *PhyloTree* instances are automatically extracted from leaf names. The parsing method can be easily adapted to any formatting:

```
from ete2 import PhyloTree

# load the whole leaf name as species taxid
tree = PhyloTree('((9606, 9598), 10090);', sp_naming_function=lambda name: name)
tax2names, tax2lineages, tax2rank = tree.annotate_ncbi_taxa()

# split names by '|' and return the first part as the species taxid
tree = PhyloTree('((9606|protA, 9598|protA), 10090|protB);', sp_naming_function=lambda name: name)
```

```
tax2names, tax2lineages, tax2rank = tree.annotate_ncbi_taxa()

print tree.get_ascii(attributes=["name", "sci_name", "taxid"])

#                                     /-9606|protA, Homo sapiens, 9606
#                                     /, Homininae, 207598
#-, Euarchontoglires, 314146          \-9598|protA, Pan troglodytes, 9598
#                                     |
#                                     \-10090|protB, Mus musculus, 10090
```

Alternatively, you can also use the `NCBITaxa.annotate_tree()` function to annotate a custom tree instance.

```
from ete2 import Tree, NCBITaxa
ncbi = NCBITaxa()
tree = Tree("")
ncbi.annotate_tree(tree, taxid_attr="name")
```

2.9 SCRIPTS: orthoXML

Contents

- *SCRIPTS: orthoXML*
 - *OrthoXML parser*
 - *The etree2orthoxml script*
 - * *Usage*
 - * *Example: Using custom evolutionary annotation*
 - * *Example: Automatic detection of species names*
 - * *Example: Tree rooting*

2.9.1 OrthoXML parser

`etree2orthoxml` is a python script distributed as a part of the ETE toolkit package. It uses an automatic python parser generated on the basis of the OrthoXML schema to convert the evolutionary events in phylogenetic tree topologies into the orthoXML format.

ETE OrthoXML parser is a low level python module that allows to operate with the orthoXML structure using python objects. Every element defined in the orthoXML schema has its akin in the parser module, so a complete orthoXML structure can be generated from scratch within a python script. In other words, low level access to the orthoXML parser allows to create orthoxml documents in a programmatic way.

The following example will create a basic orthoXML document

```
from ete2 import orthoxml
# Creates an empty orthoXML object
oxml = orthoxml.orthoXML()

# Add an ortho group container to the orthoXML document
ortho_groups = orthoxml.groups()
oxml.set_groups(ortho_groups)
```



```
# Add an orthology group including two sequences
orthologs = orthoxml.group()
orthologs.add_geneRef(orthoxml.geneRef(1))
orthologs.add_geneRef(orthoxml.geneRef(2))
ortho_groups.add_orthologGroup(orthologs)

oxml_file = open("test_orthoxml.xml", "w")
oxml.export(oxml_file, level=0)
oxml_file.close()

# producing the following output
#<ortho:orthoXML>
#  <ortho:groups>
#    <ortho:orthologGroup>
#      <ortho:geneRef id="1"/>
#      <ortho:geneRef id="2"/>
#    </ortho:orthologGroup>
#  </ortho:groups>
#</ortho:orthoXML>
```

2.9.2 The etree2orthoxml script

etree2orthoxml is a standalone python script that allows to read a phylogenetic tree in newick format and export their evolutionary events (duplication and speciation events) as an orthoXML document. The program is installed along with ETE, so it should be found in your path. Alternatively you can find it in the script folder of the latest ETE package release (<http://etetoolkit.org/releases/ete2/>).

To work, etree2orthoxml requires only one argument containing the newick representation of a tree or the name of the file that contains it. By default, automatic detection of speciation and duplication events will be carried out using the built-in *species overlap algorithm*, although this behavior can be easily disabled when event information is provided along with the newick tree. In the following sections you will find some use case examples.

Also, consider reading the source code of the script. It is documented and it can be used as a template for more specific applications. Note that etree2orthoxml is a work in progress, so feel free to use the [etetoolkit mailing list](#) to report any feedback or improvement to the code.

Usage

```
usage: etree2orthoxml [-h] [--sp_delimiter SPECIES_DELIMITER]
                    [--sp_field SPECIES_FIELD] [--root [ROOT [ROOT ...]]]
                    [--skip_ortholog_detection]
                    [--evoltype_attr EVOLTYPE_ATTR] [--database DATABASE]
                    [--show] [--ascii] [--newick]
                    tree_file
```

etree2orthoxml is a python script that extracts evolutionary events (speciation and duplication) from a newick tree and exports them as a OrthoXML file.

positional arguments:

tree_file A tree file (or text string) in newick format.

```
optional arguments:
-h, --help                show this help message and exit
--sp_delimiter SPECIES_DELIMITER
                          When species names are guessed from node names, this
                          argument specifies how to split node name to guess the
                          species code
--sp_field SPECIES_FIELD
                          When species names are guessed from node names, this
                          argument specifies the position of the species name
                          code relative to the name splitting delimiter
--root [ROOT [ROOT ...]]
                          Roots the tree to the node grouping the list of node
                          names provided (space separated). In example: '--root
                          human rat mouse'
--skip_ortholog_detection
                          Skip automatic detection of speciation and duplication
                          events, thus relying in the correct annotation of the
                          provided tree using the extended newick format (i.e.
                          '((A, A)[&&NHX:evoltype=D], B)[&&NHX:evoltype=S];')
--evoltype_attr EVOLTYPE_ATTR
                          When orthology detection is disabled, the attribute
                          name provided here will be expected to exist in all
                          internal nodes and read from the extended newick
                          format
--database DATABASE      Database name
--show                   Show the tree and its evolutionary events before
                          orthoXML export
--ascii                  Show the tree using ASCII representation and all its
                          evolutionary events before orthoXML export
--newick                 print the extended newick format for provided tree
                          using ASCII representation and all its evolutionary
                          events before orthoXML export
```

Example: Using custom evolutionary annotation

If all internal nodes in the provided tree are correctly label as duplication or speciation nodes, automatic detection of events can be disabled using the `--skip_ortholog_detection` flag.

Node labeling should be provided using the extended newick format. Duplication nodes should contain the label `evoltype` set to `D`, while speciation nodes should be set to `evoltype=S`. If tag names is different, the option `evoltype_attr` can be used as convenient.

In the following example, we force the HUMAN clade to be considered a speciation node.

```
# etree2orthoxml --skip_ortholog_detection '((HUMAN_A, HUMAN_B)[&&NHX:evoltype=S], MOUSE)

<orthoXML>
  <species name="A">
    <database name="">
      <genes>
        <gene protId="HUMAN_A" id="0"/>
      </genes>
    </database>
  </species>
  <species name="B">
    <database name="">
```

```

        <genes>
          <gene protId="HUMAN_B" id="1"/>
          <gene protId="MOUSE_B" id="2"/>
        </genes>
      </database>
    </species>
    <groups>
      <orthologGroup>
        <geneRef id="2"/>
      </orthologGroup>
      <orthologGroup>
        <geneRef id="0"/>
        <geneRef id="1"/>
      </orthologGroup>
    </orthologGroup>
  </groups>
</orthoXML>

```

You can avoid tree reformatting when node labels are slightly different by using the `evoltype_attr`:

```
# etree2orthoxml --evoltype_attr E --skip_ortholog_detection '((HUMAN_A, HUMAN_B)[&&NHX:speciation=N],
```

However, more complex modifications on raw trees can be easily performed using the core methods of the ETE library, so they match the requirements of the `etree2orthoxml` script.

```

from ete2 import Tree
# Having the followin tree
t = Tree('((HUMAN_A, HUMAN_B)[&&NHX:speciation=N], MOUSE_B)[&&NHX:speciation=Y];')

# We read the speciation tag from nodes and convert it into a valid evoltree label
for node in t.traverse():
    if not node.is_leaf():
        etype = "D" if node.speciation == "N" else "S"
        node.add_features(evoltype=etype)

# We the export a newick string that is compatible with etree2orthoxml script
t.write(features=["evoltype"], format_root_node=True)

# converted newick:
# '((HUMAN_A:1,HUMAN_B:1)1:1[&&NHX:evoltype=D],MOUSE_B:1)1:1[&&NHX:evoltype=S];'

```

Example: Automatic detection of species names

As different databases and software may produce slightly different newick tree formats, the script provides several customization options.

In gene family trees, species names are usually encoded as a part of leaf names (i.e. P53_HUMAN). If such codification follows a simple rule, `etree2orthoxml` can automatically detect species name and used to populate the relevant sections within the orthoXML document.

For this, the `sp_delimiter` and `sp_field` arguments can be used. Note how species are correctly detected in the following example:

```

# etree2orthoxml --database TestDB --evoltype_attr E --skip_ortholog_detection --sp_delim
<orthoXML>
  <species name="HUMAN">
    <database name="TestDB">
      <genes>

```

```

        <gene protId="HUMAN_A" id="0"/>
        <gene protId="HUMAN_B" id="1"/>
    </genes>
</database>
</species>
<species name="MOUSE">
    <database name="TestDB">
        <genes>
            <gene protId="MOUSE_B" id="2"/>
        </genes>
    </database>
</species>
<groups>
    <orthologGroup>
        <geneRef id="2"/>
    </orthologGroup>
    <orthologGroup>
        <geneRef id="0"/>
        <geneRef id="1"/>
    </orthologGroup>
</orthologGroup>
</groups>
</orthoXML>

```

Example: Tree rooting

When evolutionary events are expected to be automatically inferred from tree topology, outgroup information can be passed to the program to root the tree before performing the detection.

```

# etree2orthoxml --ascii --root FLY_1 FLY_2 --sp_delimiter '_' --sp_field 0 '(HUMAN_A,

```

```

        /-FLY_1
    /D, NoName
    |          \-FLY_2
-S, NoName
    |
    |          /-HUMAN_A
    |          /D, NoName
    \S, NoName \-HUMAN_B
    |
    |          \-MOUSE_B

```

```

<orthoXML>
    <species name="FLY">
        <database name="">
            <genes>
                <gene protId="FLY_1" id="0"/>
                <gene protId="FLY_2" id="1"/>
            </genes>
        </database>
    </species>
    <species name="HUMAN">
        <database name="">
            <genes>
                <gene protId="HUMAN_A" id="2"/>

```

```
        <gene protId="HUMAN_B" id="3"/>
      </genes>
    </database>
  </species>
  <species name="MOUSE">
    <database name="">
      <genes>
        <gene protId="MOUSE_B" id="4"/>
      </genes>
    </database>
  </species>
  <groups>
    <orthologGroup>
      <paralogGroup>
        <geneRef id="0"/>
        <geneRef id="1"/>
      </paralogGroup>
      <orthologGroup>
        <geneRef id="4"/>
        <paralogGroup>
          <geneRef id="2"/>
          <geneRef id="3"/>
        </paralogGroup>
      </orthologGroup>
    </orthologGroup>
  </groups>
</orthoXML>
```

ETE's Reference Guide

Current modules:

3.1 Master Tree class

class `TreeNode` (*newick=None, format=0, dist=None, support=None, name=None*)

`TreeNode` (`Tree`) class is used to store a tree structure. A tree consists of a collection of `TreeNode` instances connected in a hierarchical way. Trees can be loaded from the New Hampshire Newick format (`newick`).

Parameters

- **`newick`** – Path to the file containing the tree or, alternatively, the text string containing the same information.
- **`format`** (*0*) – subnewick format

FORMAT	DESCRIPTION
0	flexible with support values
1	flexible with internal node names
2	all branches + leaf names + internal supports
3	all branches + all names
4	leaf branches + leaf names
5	internal and leaf branches + leaf names
6	internal branches + leaf names
7	leaf branches + all names
8	all names
9	leaf names
100	topology only

Returns a tree node object which represents the base of the tree.

** Examples: **

```
t1 = Tree() # creates an empty tree
t2 = Tree(' (A:1, (B:1, (C:1,D:1):0.5):0.5);')
t3 = Tree('/home/user/myNewickFile.txt')
```

`add_child` (*child=None, name=None, dist=None, support=None*)

Adds a new child to this node. If child node is not supplied as an argument, a new node instance will be created.

Parameters

- **child** (*None*) – the node instance to be added as a child.
- **name** (*None*) – the name that will be given to the child.
- **dist** (*None*) – the distance from the node to the child.
- **support'** (*None*) – the support value of child partition.

Returns The child node instance

add_face (*face, column, position='branch-right'*)

Add a fixed face to the node. This type of faces will be always attached to nodes, independently of the layout function.

Parameters

- **face** – a Face or inherited instance
- **column** – An integer number starting from 0
- **position** (“*branch-right*”) – Possible values are: “*branch-right*”, “*branch-top*”, “*branch-bottom*”, “*float*”, “*aligned*”

add_feature (*pr_name, pr_value*)

Add or update a node’s feature.

add_features (***features*)

Add or update several features.

add_sister (*sister=None, name=None, dist=None*)

Adds a sister to this node. If sister node is not supplied as an argument, a new `TreeNode` instance will be created and returned.

check_monophyly (*values, target_attr, ignore_missing=False, unrooted=False*)

Returns True if a given target attribute is monophyletic under this node for the provided set of values.

If not all values are represented in the current tree structure, a `ValueError` exception will be raised to warn that strict monophyly could never be reached (this behaviour can be avoided by enabling the *ignore_missing* flag).

Parameters

- **values** – a set of values for which monophyly is expected.
- **target_attr** – node attribute being used to check monophyly (i.e. species for species trees, names for gene family trees, or any custom feature present in the tree).
- **ignore_missing** (*False*) – Avoid raising an Exception when missing attributes are found.

Parameters unrooted (*False*) – If True, tree will be treated as unrooted, thus allowing to find monophyly even when current outgroup is splitting a monophyletic group.

Returns the following tuple `IsMonophyletic` (boolean), clade type (‘*monophyletic*’, ‘*paraphyletic*’ or ‘*polyphyletic*’), leaves breaking the monophyly (set)

children

A list of children nodes

compare (*ref_tree*, *use_collateral=False*, *min_support_source=0.0*,
min_support_ref=0.0, *has_duplications=False*, *expand_polytomies=False*, *unrooted=False*, *max_treeko_splits_to_be_artifact=1000*, *ref_tree_attr='name'*,
source_tree_attr='name')

compare this tree with another using robinson foulds symmetric difference and number of shared edges. Trees of different sizes and with duplicated items allowed.

returns: a Python dictionary with results

convert_to_ultrametric (*tree_length=None*, *strategy='balanced'*)

Converts a tree into ultrametric topology (all leaves must have the same distance to root). Note that, for visual inspection of ultrametric trees, `node.img_style["size"]` should be set to 0.

copy (*method='cpickle'*)

Returns a copy of the current node.

Variables method (*cpickle*) – Protocol used to copy the node

structure. The following values are accepted:

- “newick”: Tree topology, node names, branch lengths and branch support values will be copied by as represented in the newick string (copy by newick string serialisation).
- “newick-extended”: Tree topology and all node features will be copied based on the extended newick format representation. Only node features will be copied, thus excluding other node attributes. As this method is also based on newick serialisation, features will be converted into text strings when making the copy.
- “cpickle”: The whole node structure and its content is cloned based on cPickle object serialisation (slower, but recommended for full tree copying)
- “deepcopy”: The whole node structure and its content is copied based on the standard “copy” Python functionality (this is the slowest method but it allows to copy complex objects even if attributes point to lambda functions, etc.)

del_feature (*pr_name*)

Permanently deletes a node’s feature.

delete (*prevent_nondicotomic=True*, *preserve_branch_length=False*)

Deletes node from the tree structure. Notice that this method makes ‘disappear’ the node from the tree structure. This means that children from the deleted node are transferred to the next available parent.

Parameters prevent_nondicotomic (*True*) – When True (default), delete

function will be execute recursively to prevent single-child nodes.

Parameters preserve_branch_length (*False*) – If True, branch lengths

of the deleted nodes are transferred (summed up) to its parent’s branch, thus keeping original distances among nodes.

Example:

```

      / C
root-|
```

```

      |          / B
      \---- H |
              \ A

> H.delete() will produce this structure:

      / C
      |
root-|--B
      |
      \ A

```

describe ()

Prints general information about this node and its connections.

detach ()

Detaches this node (and all its descendants) from its parent and returns the referent to itself.

Detached node conserves all its structure of descendants, and can be attached to another node through the 'add_child' function. This mechanism can be seen as a cut and paste.

dist

Branch length distance to parent node. Default = 0.0

expand_polytomies (*map_attr='name', polytomy_size_limit=5,*
skip_large_polytomies=False)

New in version 2.3.

Given a tree with one or more polytomies, this functions returns the list of all trees (in newick format) resulting from the combination of all possible solutions of the multifurcated nodes.

<http://ajmonline.org/2010/darwin.php>

get_ancestors ()

versionadded: 2.2

Returns the list of all ancestor nodes from current node to the current tree root.

get_ascii (*show_internal=True, compact=False, attributes=None*)

Returns a string containing an ascii drawing of the tree.

Parameters

- **show_internal** – includes internal edge names.
- **compact** – use exactly one line per tip.
- **attributes** – A list of node attributes to shown in the ASCII representation.

get_cached_content (*store_attr=None, container_type=<type 'set'>, _store=None*)

Returns a dictionary pointing to the preloaded content of each internal node under this tree. Such a dictionary is intended to work as a cache for operations that require many traversal operations.

Parameters store_attr (*None*) – Specifies the node attribute that

should be cached (i.e. name, distance, etc.). When none, the whole node instance is cached.

Parameters _store – (internal use)

get_children()
Returns an independent list of node's children.

get_closest_leaf (*topology_only=False, is_leaf_fn=None*)
Returns node's closest descendant leaf and the distance to it.

Parameters topology_only (*False*) – If set to True, distance between nodes will be referred to the number of nodes between them. In other words, topological distance will be used instead of branch length distances.

Returns A tuple containing the closest leaf referred to the current node and the distance to it.

get_common_ancestor (**target_nodes, **kargs*)
Returns the first common ancestor between this node and a given list of 'target_nodes'.

Examples:

```
t = tree.Tree("((A:0.1, B:0.01):0.001, C:0.0001):1.0[&&NHX:name=common], (D:0.01):0.001)
A = t.get_descendants_by_name("A")[0]
C = t.get_descendants_by_name("C")[0]
common = A.get_common_ancestor(C)
print common.name
```

get_descendants (*strategy='levelorder', is_leaf_fn=None*)
Returns a list of all (leaves and internal) descendant nodes.

Parameters is_leaf_fn (*None*) – See *TreeNode.traverse()* for documentation.

get_distance (*target, target2=None, topology_only=False*)
Returns the distance between two nodes. If only one target is specified, it returns the distance between the target and the current node.

Parameters

- **target** – a node within the same tree structure.
- **target2** – a node within the same tree structure. If not specified, current node is used as target2.
- **topology_only** (*False*) – If set to True, distance will refer to the number of nodes between target and target2.

Returns branch length distance between target and target2. If topology_only flag is True, returns the number of nodes between target and target2.

get_edges (*cached_content=None*)
New in version 2.3.

Returns the list of edges of a tree. Each edge is represented as a tuple of two elements, each containing the list of nodes separated by the edge.

get_farthest_leaf (*topology_only=False, is_leaf_fn=None*)
Returns node's farthest descendant node (which is always a leaf), and the distance to it.

Parameters topology_only (*False*) – If set to True, distance between nodes will be referred to the number of nodes between them. In other words, topological distance will be used instead of branch length distances.

Returns A tuple containing the farthest leaf referred to the current node and the distance to it.

get_farthest_node (*topology_only=False*)

Returns the node's farthest descendant or ancestor node, and the distance to it.

Parameters **topology_only** (*False*) – If set to True, distance between nodes will be referred to the number of nodes between them. In other words, topological distance will be used instead of branch length distances.

Returns A tuple containing the farthest node referred to the current node and the distance to it.

get_leaf_names (*is_leaf_fn=None*)

Returns the list of terminal node names under the current node.

Parameters **is_leaf_fn** (*None*) – See `TreeNode.traverse()` for documentation.

get_leaves (*is_leaf_fn=None*)

Returns the list of terminal nodes (leaves) under this node.

Parameters **is_leaf_fn** (*None*) – See `TreeNode.traverse()` for documentation.

get_leaves_by_name (*name*)

Returns a list of leaf nodes matching a given name.

get_midpoint_outgroup ()

Returns the node that divides the current tree into two distance-balanced partitions.

get_monophyletic (*values, target_attr*)

New in version 2.2.

Returns a list of nodes matching the provided monophyly criteria. For a node to be considered a match, all *target_attr* values within and node, and exclusively them, should be grouped.

Parameters

- **values** – a set of values for which monophyly is expected.
- **target_attr** – node attribute being used to check monophyly (i.e. species for species trees, names for gene family trees).

get_sisters ()

Returns an independent list of sister nodes.

get_topology_id (*attr='name'*)

New in version 2.3.

Returns the unique ID representing the topology of the current tree. Two trees with the same topology will produce the same id. If trees are unrooted, make sure that the root node is not binary or use the `tree.unroot()` function before generating the topology id.

This is useful to detect the number of unique topologies over a bunch of trees, without requiring full distance methods.

The id is, by default, calculated based on the terminal node's names. Any other node attribute could be used instead.

get_tree_root ()

Returns the absolute root node of current tree structure.

img_style

Branch length distance to parent node. Default = 0.0

is_leaf ()

Return True if current node is a leaf.

is_root ()

Returns True if current node has no parent

iter_ancestors ()

versionadded: 2.2

Iterates over the list of all ancestor nodes from current node to the current tree root.

iter_descendants (strategy='levelorder', is_leaf_fn=None)

Returns an iterator over all descendant nodes.

Parameters is_leaf_fn (None) – See `TreeNode.traverse()` for documentation.

iter_edges (cached_content=None)

New in version 2.3.

Iterate over the list of edges of a tree. Each edge is represented as a tuple of two elements, each containing the list of nodes separated by the edge.

iter_leaf_names (is_leaf_fn=None)

Returns an iterator over the leaf names under this node.

Parameters is_leaf_fn (None) – See `TreeNode.traverse()` for documentation.

iter_leaves (is_leaf_fn=None)

Returns an iterator over the leaves under this node.

Parameters is_leaf_fn (None) – See `TreeNode.traverse()` for documentation.

iter_prepostorder (is_leaf_fn=None)

Iterate over all nodes in a tree yielding every node in both pre and post order. Each iteration returns a postorder flag (True if node is being visited in postorder) and a node instance.

iter_search_nodes (conditions)**

Search nodes in an iterative way. Matches are being yield as they are being found. This avoids to scan the full tree topology before returning the first matches. Useful when dealing with huge trees.

ladderize (direction=0)

Sort the branches of a given tree (swapping children nodes) according to the size of each partition.

```
t = Tree("(f, ((d, ((a,b),c)),e));")

print t

#
#      /-f
```

```

#      /
#      /      /-d
# ----|      /
#      /      /----|      /-a
#      /      /      /      /----|
#      /      /      \----|      \-b
#      \----|      /
#      /      \-c
#      /
#      \-e

t.ladderize()
print t

#      /-f
# ----|
#      /      /-e
#      \----|
#      /      /-d
#      \----|
#      /      /-c
#      \----|
#      /      /-a
#      \----|
#      \-b

```

populate (*size*, *names_library=None*, *reuse_names=False*, *random_branches=False*, *branch_range=(0, 1)*, *support_range=(0, 1)*)
 Generates a random topology by populating current node.

Parameters

- **names_library** (*None*) – If provided, names library (list, set, dict, etc.) will be used to name nodes.
- **reuse_names** (*False*) – If True, node names will not be necessarily unique, which makes the process a bit more efficient.
- **random_branches** (*False*) – If True, branch distances and support values will be randomized.
- **branch_range** (*(0,1)*) – If *random_branches* is True, this

range of values will be used to generate random distances.

Parameters support_range (*(0,1)*) – If *random_branches* is True, this range of values will be used to generate random branch support values.

prune (*nodes*, *preserve_branch_length=False*)

Prunes the topology of a node to conserve only the selected list of leaf internal nodes. The minimum number of nodes that conserve the topological relationships among the requested nodes will be retained. Root node is always conserved.

Variables nodes – a list of node names or node objects that should be retained

Parameters preserve_branch_length (*False*) – If True, branch lengths of the deleted nodes are transferred (summed up) to its parent’s branch, thus keeping original distances among nodes.

Examples:

```
t1 = Tree('((((A,B)C)D,E)F,G)H, (I,J)K)root;', format=1)
t1.prune(['A', 'B'])
```

```
#           /-A
#           /D /C|
#           /F|   \-B
#           | |
#           /H|   \-E
#           | |
#-root  \-G           -root
#           |           \-B
#           | /-I
#           \K|
#           \-J
```

```
t1 = Tree('((((A,B)C)D,E)F,G)H, (I,J)K)root;', format=1)
t1.prune(['A', 'B', 'C'])
```

```
#           /-A
#           /D /C|
#           /F|   \-B
#           | |
#           /H|   \-E
#           | |
#-root  \-G           -root- C|
#           |           \-B
#           | /-I
#           \K|
#           \-J
```

```
t1 = Tree('((((A,B)C)D,E)F,G)H, (I,J)K)root;', format=1)
t1.prune(['A', 'B', 'I'])
```

```
#           /-A
#           /D /C|
#           /F|   \-B
#           | |
#           /H|   \-E
#           | |
#-root  \-G           -root
#           |           | /-A
#           |           \C|
#           | /-I           \-B
#           \K|
#           \-J
```

```
t1 = Tree('((((A,B)C)D,E)F,G)H, (I,J)K)root;', format=1)
t1.prune(['A', 'B', 'F', 'H'])
```

```
#           /-A
#           /D /C|
```

```

#      /F|      \-B
#      |  |
#      /H|      \-E
#      |  |
#-root \-G      -root-H /F|
#      |      \-B
#      | /-I
#      \K|
#      \-J

```

remove_child (*child*)

Removes a child from this node (parent and child nodes still exist but are no longer connected).

remove_sister (*sister=None*)

Removes a sister node. It has the same effect as ‘**TreeNode.up.remove_child(sister)**’

If a sister node is not supplied, the first sister will be deleted and returned.

Parameters *sister* – A node instance

Returns The node removed

render (*file_name, layout=None, w=None, h=None, tree_style=None, units='px', dpi=90*)

Renders the node structure as an image.

Variables

- **file_name** – path to the output image file. valid extensions are .SVG, .PDF, .PNG
- **layout** – a layout function or a valid layout function name
- **tree_style** – a *TreeStyle* instance containing the image properties
- **units** (*px*) – “px”: pixels, “mm”: millimeters, “in”: inches
- **h** (*None*) – height of the image in *units*
- **w** (*None*) – weight of the image in *units*
- **dpi** (*300*) – dots per inches.

resolve_polytomy (*default_dist=0.0, default_support=0.0, recursive=True*)

Resolve all polytomies under current node by creating an arbitrary dicotomic structure among the affected nodes. This function randomly modifies current tree topology and should only be used for compatibility reasons (i.e. programs rejecting multifurcated node in the newick representation).

Parameters

- **default_dist** (*0.0*) – artificial branch distance of new nodes.
- **default_support** (*0.0*) – artificial branch support of new nodes.
- **recursive** (*True*) – Resolve any polytomy under this node. When False, only current node will be checked and fixed.

robinson_foulds (*t2*, *attr_t1='name'*, *attr_t2='name'*, *unrooted_trees=False*,
expand_polytomies=False, *polytomy_size_limit=5*,
skip_large_polytomies=False, *correct_by_polytomy_size=False*,
min_support_t1=0.0, *min_support_t2=0.0*)

Returns the Robinson-Foulds symmetric distance between current tree and a different tree instance.

Parameters

- **t2** – reference tree
- **attr_t1** (*name*) – Compare trees using a custom node attribute as a node name.
- **attr_t2** (*False*) – Compare trees using a custom node attribute as a node name in target tree.
- **attr_t2** – If True, consider trees as unrooted.
- **expand_polytomies** (*False*) – If True, all polytomies in the reference and target tree will be expanded into all possible binary trees. Robinson-foulds distance will be calculated between all tree combinations and the minimum value will be returned. See also, `NodeTree.expand_polytomy()`.

Returns (*rf*, *rf_max*, *common_attrs*, *names*, *edges_t1*, *edges_t2*, *discarded_edges_t1*, *discarded_edges_t2*)

search_nodes (***conditions*)

Returns the list of nodes matching a given set of conditions.

Example:

```
tree.search_nodes(dist=0.0, name="human")
```

set_outgroup (*outgroup*)

Sets a descendant node as the outgroup of a tree. This function can be used to root a tree or even an internal node.

Parameters outgroup – a node instance within the same tree structure that will be used as a basal node.

set_style (*node_style*)

Set 'node_style' as the fixed style for the current node.

show (*layout=None*, *tree_style=None*, *name='ETE'*)

Starts an interactive session to visualize current node structure using provided layout and TreeStyle.

sort_descendants (*attr='name'*)

This function sort the branches of a given tree by considering node names. After the tree is sorted, nodes are labeled using ascendent numbers. This can be used to ensure that nodes in a tree with the same node names are always labeled in the same way. Note that if duplicated names are present, extra criteria should be added to sort nodes.

Unique id is stored as a node._nid attribute

standardize (*delete_orphan=True*, *preserve_branch_length=True*)

New in version 2.3.

process current tree structure to produce a standardized topology: nodes with only one child are removed and multifurcations are automatically resolved.

support

Branch support for current node

swap_children()

Swaps current children order.

traverse (*strategy='levelorder', is_leaf_fn=None*)

Returns an iterator to traverse the tree structure under this node.

Parameters

- **strategy** (*"levelorder"*) – set the way in which tree will be traversed. Possible values are: “preorder” (first parent and then children) ‘postorder’ (first children and the parent) and “levelorder” (nodes are visited in order from root to leaves)
- **is_leaf_fn** (*None*) – If supplied, *is_leaf_fn* function will be used to interrogate nodes about if they are terminal or internal. *is_leaf_fn* function should receive a node instance as first argument and return True or False. Use this argument to traverse a tree by dynamically collapsing internal nodes matching *is_leaf_fn*.

unroot()

Unroots current node. This function is expected to be used on the absolute tree root node, but it can be also be applied to any other internal node. It will convert a split into a multifurcation.

up

Pointer to parent node

write (*features=None, outfile=None, format=0, is_leaf_fn=None, format_root_node=False, dist_formatter=None, support_formatter=None, name_formatter=None*)

Returns the newick representation of current node. Several arguments control the way in which extra data is shown for every node:

Parameters

- **features** – a list of feature names to be exported using the Extended Newick Format (i.e. *features=["name", "dist"]*). Use an empty list to export all available features in each node (*features=[]*)
- **outfile** – writes the output to a given file
- **format** – defines the newick standard used to encode the tree. See tutorial for details.
- **format_root_node** (*False*) – If True, it allows features and branch information from root node to be exported as a part of the newick text string. For newick compatibility reasons, this is False by default.
- **is_leaf_fn** – See *TreeNode.traverse()* for documentation.

Example:

```
t.get_newick(features=["species", "name"], format=1)
```

Tree

alias of *TreeNode*

3.2 Treeview module

Contents

- *Treeview module*
 - *TreeStyle*
 - *NodeStyle*
 - *Faces*
 - *Color names*

3.2.1 TreeStyle

class TreeStyle

New in version 2.1.

Contains all the general image properties used to render a tree

– About tree design –

Parameters **layout_fn** (*None*) – Layout function used to dynamically control the aspect of nodes. Valid values are: None or a pointer to a method, function, etc.

– About tree shape –

Parameters

- **mode** (“r”) – Valid modes are ‘c’(ircular) or ‘r’(ectangular).
- **orientation** (0) – If 0, tree is drawn from left-to-right. If 1, tree is drawn from right-to-left. This property only makes sense when “r” mode is used.
- **rotation** (0) – Tree figure will be rotate X degrees (clock-wise rotation).
- **min_leaf_separation** (1) – Min separation, in pixels, between two adjacent branches
- **branch_vertical_margin** (0) – Leaf branch separation margin, in pixels. This will add a separation of X pixels between adjacent leaf branches. In practice, increasing this value work as increasing Y axis scale.
- **arc_start** (0) – When circular trees are drawn, this defines the starting angle (in degrees) from which leaves are distributed (clock-wise) around the total arc span (0 = 3 o’clock).
- **arc_span** (359) – Total arc used to draw circular trees (in degrees).
- **margin_left** (0) – Left tree image margin, in pixels.
- **margin_right** (0) – Right tree image margin, in pixels.
- **margin_top** (0) – Top tree image margin, in pixels.
- **margin_bottom** (0) – Bottom tree image margin, in pixels.

– About Tree branches –

Parameters

- **scale** (*None*) – Scale used to draw branch lengths. If *None*, it will be automatically calculated.
- **optimal_scale_level** (“*mid*”) – Two levels of automatic branch scale detection are available: “*mid*” and “*full*”. In *full* mode, branch scale will be adjusted to fully avoid dotted lines in the tree image. In other words, scale will be increased until the extra space necessary to allocate all branch-top/bottom faces and branch-right faces (in circular mode) is covered by real branches. Note, however, that the optimal scale in trees with very unbalanced branch lengths might be huge. If “*mid*” mode is selected (as it is by default), optimal scale will only satisfy the space necessary to allocate branch-right faces in circular trees. Some dotted lines (artificial branch offsets) will still appear when branch-top/bottom faces are larger than branch length. Note that both options apply only when *scale* is set to *None* (automatic).
- **root_opening_factor** (*0.25*) – (from 0 to 1). It defines how much the center of a circular tree could be opened when adjusting optimal scale, referred to the total tree length. By default (*0.25*), a blank space up to 4 times smaller than the tree width could be used to calculate the optimal tree scale. A 0 value would mean that root node should always be tightly adjusted to the center of the tree.
- **complete_branch_lines_when_necessary** (*True*) – True or False. Draws an extra line (dotted by default) to complete branch lengths when the space to cover is larger than the branch itself.
- **extra_branch_line_type** (*2*) – 0=solid, 1=dashed, 2=dotted
- **extra_branch_line_color** (“*gray*”) – RGB code or name in *SVG_COLORS*
- **force_topology** (*False*) – Convert tree branches to a fixed length, thus allowing to observe the topology of tight nodes
- **draw_guiding_lines** (*False*) – Draw guidelines from leaf nodes to aligned faces
- **guiding_lines_type** (*2*) – 0=solid, 1=dashed, 2=dotted.
- **guiding_lines_color** (“*gray*”) – RGB code or name in *SVG_COLORS*

– About node faces –

Parameters

- **allow_face_overlap** (*False*) – If *True*, node faces are not taken into account to scale circular tree images, just like many other visualization programs. Overlapping among branch elements (such as node labels) will be therefore ignored, and tree size will be a lot smaller. Note that in most cases, manual setting of tree scale will be also necessary.
- **draw_aligned_faces_as_table** (*True*) – Aligned faces will be drawn as a table, considering all columns in all node faces.

- **children_faces_on_top** (*True*) – When floating faces from different nodes overlap, children faces are drawn on top of parent faces. This can be reversed by setting this attribute to false.

– Addons –

Parameters

- **show_border** (*False*) – Draw a border around the whole tree
- **show_scale** (*True*) – Include the scale legend in the tree image
- **show_leaf_name** (*False*) – Automatically adds a text Face to leaf nodes showing their names
- **show_branch_length** (*False*) – Automatically adds branch length information on top of branches
- **show_branch_support** (*False*) – Automatically adds branch support text in the bottom of tree branches

– Tree surroundings –

The following options are actually Face containers, so graphical elements can be added just as it is done with nodes. In example, to add tree legend:

```
TreeStyle.legend.add_face(CircleFace(10, "red"), column=0)
TreeStyle.legend.add_face(TextFace("0.5 support"), column=1)
```

Parameters

- **aligned_header** – a *FaceContainer* aligned to the end of the tree and placed at the top part.
- **aligned_foot** – a *FaceContainer* aligned to the end of the tree and placed at the bottom part.
- **legend** – a *FaceContainer* with an arbitrary number of faces representing the legend of the figure.
- **legend_position=4** (4) – TopLeft corner if 1, TopRight if 2, BottomLeft if 3, BottomRight if 4
- **title** – A Face container that can be used as tree title

class FaceContainer

New in version 2.1.

Use this object to create a grid of faces. You can add faces to different columns.

add_face (*face, column*)

add the face **face** to the specified **column**

3.2.2 NodeStyle

class NodeStyle (**args, **kargs*)

New in version 2.1.

A dictionary with all valid node graphical attributes.

Parameters

- **fgcolor** (*#0030c1*) – RGB code or name in *SVG_COLORS*
- **bgcolor** (*#FFFFFF*) – RGB code or name in *SVG_COLORS*
- **node_bgcolor** (*#FFFFFF*) – RGB code or name in *SVG_COLORS*
- **partition_bgcolor** (*#FFFFFF*) – RGB code or name in *SVG_COLORS*
- **faces_bgcolor** (*#FFFFFF*) – RGB code or name in *SVG_COLORS*
- **vt_line_color** (*#000000*) – RGB code or name in *SVG_COLORS*
- **hz_line_color** (*#000000*) – RGB code or name in *SVG_COLORS*
- **hz_line_type** (*0*) – integer number
- **vt_line_type** (*0*) – integer number
- **size** (*3*) – integer number
- **shape** (*“circle”*) – “circle”, “square” or “sphere”
- **draw_descendants** (*True*) – Mark an internal node as a leaf.
- **hz_line_width** (*0*) – integer number representing the width of the line in pixels. A line width of zero indicates a cosmetic pen. This means that the pen width is always drawn one pixel wide, independent of the transformation set on the painter.
- **vt_line_width** (*0*) – integer number representing the width of the line in pixels. A line width of zero indicates a cosmetic pen. This means that the pen width is always drawn one pixel wide, independent of the transformation set on the painter.

3.2.3 Faces

add_face_to_node (*face, node, column, aligned=False, position='branch-right'*)

Adds a Face to a given node.

Parameters **face** – A Face instance

Parameters

- **node** – a tree node instance (*Tree, PhyloTree*, etc.)
- **column** – An integer number starting from 0
- **position** (*“branch-right”*) – Possible values are “branch-right”, “branch-top”, “branch-bottom”, “float”, “float-behind” and “aligned”.

class Face

Base Face object. All Face types (i.e. TextFace, SeqMotifFace, etc.) inherit the following options:

Parameters

- **margin_left** (*0*) – in pixels
- **margin_right** (*0*) – in pixels
- **margin_top** (*0*) – in pixels

- **margin_bottom** (*0*) – in pixels
- **opacity** (*1.0*) – a float number in the (0,1) range
- **rotable** (*True*) – If True, face will be rotated when necessary (i.e. when circular mode is enabled and face occupies an inverted position.)
- **hz_align** (*0*) – 0 left, 1 center, 2 right
- **vt_align** (*1*) – 0 top, 1 center, 2 bottom
- **background.color** – background color of face plus all its margins.
- **inner_background.color** – background color of the face excluding margins
- **border** – Border around face margins.
- **inner_border** – Border around face excluding margins.

border and inner_border sub-parameters:

Parameters

- **(inner_)border.type** (*0*) – 0=solid, 1=dashed, 2=dotted
- **(inner_)border.width** (*None*) – a positive integer number. Zero indicates a cosmetic pen. This means that the pen width is always drawn one pixel wide, independent of the transformation set on the painter. A “None” value means invisible border.
- **(inner_)border.color** (*black*) – RGB or color name in *SVG_COLORS*

See also specific options for each face type.

```
class TextFace (text, ftype='Verdana', fsize=10, fgcolor='black', penwidth=0,  
               fstyle='normal', tight_text=False)  
Static text Face object
```

Parameters

- **text** – Text to be drawn
- **ftype** – Font type, e.g. Arial, Verdana, Courier
- **fsize** – Font size, e.g. 10,12,6, (default=10)
- **fgcolor** – Foreground font color. RGB code or color name in *SVG_COLORS*
- **penwidth** – Penwidth used to draw the text.
- **fstyle** – “normal” or “italic”
- **tight_text** (*False*) – When False, boundaries of the text are

approximated according to general font metrics, producing slightly worse aligned text faces but improving the performance of tree visualization in scenes with a lot of text faces.

```
class AttrFace (attr, ftype='Verdana', fsize=10, fgcolor='black', penwidth=0, text_prefix='',  
               text_suffix='', formatter=None, fstyle='normal', tight_text=False)  
Dynamic text Face. Text rendered is taken from the value of a given node attribute.
```

Parameters

- **attr** – Node’s attribute that will be drawn as text
- **ftype** – Font type, e.g. Arial, Verdana, Courier, (default=“Verdana”)
- **fsize** – Font size, e.g. 10,12,6, (default=10)
- **fgcolor** – Foreground font color. RGB code or name in *SVG_COLORS*
- **penwidth** – Penwidth used to draw the text. (default is 0)
- **text_prefix** – text_rendered before attribute value
- **text_suffix** – text_rendered after attribute value
- **formatter** – a text string defining a python formater to process the attribute value before renderer. e.g. “%0.2f”
- **fstyle** – “normal” or “italic”

class **ImgFace** (*img_file*, *width=None*, *height=None*)

Creates a node Face using an external image file.

Parameters

- **img_file** – path to the image file.
- **width** (*None*) – if provided, image will be scaled to this width (in pixels)
- **height** (*None*) – if provided, image will be scaled to this height (in pixels)

If only one dimension value (width or height) is provided, the other will be calculated to keep aspect ratio.

class **CircleFace** (*radius*, *color*, *style='circle'*)

New in version 2.1.

Creates a Circle or Sphere Face.

Parameters

- **radius** – integer number defining the radius of the face
- **color** – Color used to fill the circle. RGB code or name in *SVG_COLORS*
- **style** (“circle”) – Valid values are “circle” or “sphere”

class **RectFace** (*width*, *height*, *fgcolor*, *bgcolor*)

New in version 2.3.

Creates a Rectangular solid face.

class **StackedBarFace** (*percents*, *width*, *height*, *colors=None*, *line_color=None*)

class **SequenceFace** (*seq*, *seqtype='aa'*, *fsize=10*, *fg_colors=None*, *bg_colors=None*, *codon=None*, *col_w=None*, *alt_col_w=3*, *special_col=None*, *interactive=False*)

Creates a new molecular sequence face object. :param seq: Sequence string to be drawn :param seqtype: Type of sequence: “nt” or “aa” :param fsize: Font size, (default=10)

You can set custom colors for amino-acids or nucleotides:

Parameters

- **codon** (*None*) – a string that corresponds to the reverse translation of the amino-acid sequence

- **col_w** (*None*) – width of the column (if col_w is lower than font size, letter wont be displayed)
- **fg_colors** (*None*) – dictionary of colors for foreground, with as keys each possible character in sequences, and as value the colors
- **bg_colors** (*None*) – dictionary of colors for background, with as keys each possible character in sequences, and as value the colors
- **alt_col_w** (3) – works together with special_col option, defines the width of given columns
- **special_col** (*None*) – list of lists containing the bounds of columns to be displayed with alt_col_w as width
- **interactive** (*False*) – more info can be displayed when mouse over sequence

class InteractiveLetterItem (*arg, **karg)

This is a class

hoverEnterEvent (e)

when mouse is over

hoverLeaveEvent (e)

when mouse leaves area

class SeqMotifFace (seq=None, motifs=None, seqtype='aa', intermotif_format='line', seqtail_format='blockseq', seq_format='blockseq', scale_factor=1, shape='()'), height=10, width=10, fgcolor='slategrey', bgcolor='slategrey', gapcolor='black')

New in version 2.2.

Creates a face based on an amino acid or nucleotide sequence and a list of motif regions.

Parameters

- **seq** (*None*) – a text string containing an aa or nt sequence. If not provided, seq and compactseq motif modes will not be available.
- **motifs** (*None*) – a list of motif regions referred to original sequence. Each motif is defined as a list containing the following information:

```
motifs = [[seq.start, seq.end, shape, width, height, fgcolor, bgcolor],
          [seq.start, seq.end, shape, width, height, fgcolor, bgcolor],
          ...
          ]
```

Where:

- **seq.start**: Motif start position referred to the full sequence
- **seq.end**: Motif end position referred to the full sequence
- **shape**: Shape used to draw the motif. Available values are:
 - * o = circle or ellipse
 - * > = triangle (base to the left)
 - * < = triangle (base to the left)

- * ^ = triangle (base at bottom)
- * v = triangle (base on top)
- * <> = diamond
- * [] = rectangle
- * () = round corner rectangle
- * seq = Show a color and the corresponding letter of each sequence position
- * compactseq = Show a color for each sequence position
- **width**: total width of the motif (or sequence position width if seq motif type)
- **height**: total height of the motif (or sequence position height if seq motif type)
- **fgcolor**: color for the motif shape border
- **bgcolor**: motif background color. Color code or name can be preceded with the “rgradient:” tag to create a radial gradient effect.
- **intermotif_format** (*line*) – How should spaces among motifs be filled. Available values are: “line”, “blank”, “none” and “seq”, “compactseq”.
- **seqtail_format** (*none*) – How should remaining tail sequence be drawn. Available values are: “line”, “seq”, “compactseq” or “none”
- **seq_format** (*compactseq*) – How should sequence be rendered in case no motif regions are provided. Available values are: “seq” and “compactseq”

class BarChartFace (*values, deviations=None, width=200, height=100, colors=None, labels=None, min_value=0, max_value=None*)

New in version 2.2.

Parameters

- **values** – a list of values each representing a vertical bar.
- **width** (*200*) – width of the bar chart.
- **height** (*100*) – height of the bar chart
- **colors** (*None*) – a list of colors, one per bar value
- **label** (*None*) – a list of labels, one per bar
- **min_value** (*0*) – min value to set the scale of the chart.
- **max_value** (*None*) – max value to set the scale of the chart.

class PieChartFace (*percents, width, height, colors=None, line_color=None*)

New in version 2.2.

Parameters

- **percents** – a list of values summing up 100.
- **width** – width of the piechart
- **height** – height of the piechart

- **colors** – a list of colors (same length as percents)
- **line_color** – color used to render the border of the piechart (None=transparent)

class ProfileFace (*max_v, min_v, center_v, width=200, height=40, style='lines', colorscheme=2*)

A profile Face for ClusterNodes

Parameters

- **max_v** – maximum value used to build the build the plot scale.
- **min_v** – minimum value used to build the build the plot scale.
- **center_v** – Center value used to scale plot and heatmap.
- **width** (*200*) – Plot width in pixels.
- **height** (*40*) – Plot width in pixels.
- **style** (*lines*) – Plot style: “lines”, “bars”, “cbars” or “heatmap”.
- **colorscheme** (*2*) – colors used to create the gradient from min values to max values. 0=green & blue; 1=green & red; 2=red & blue. In all three cases, missing values are rendered in black and transition color (values=center) is white.

class TreeFace (*tree, tree_style*)

New in version 2.1.

Creates a Face containing a Tree object. Yes, a tree within a tree :)

Parameters

- **tree** – An ETE Tree instance (Tree, PhyloTree, etc...)
- **tree_style** – A TreeStyle instance defining how tree show be drawn

class StaticItemFace (*item*)

New in version 2.1.

Creates a face based on an external QGraphicsItem object. QGraphicsItem object is expected to be independent from tree node properties, so its content is assumed to be static (drawn only once, no updates when tree changes).

Parameters **item** – an object based on QGraphicsItem

class DynamicItemFace (*constructor, *args, **kargs*)

New in version 2.1.

Creates a face based on an external QGraphicsItem object whose content depends on the node that is linked to.

Parameters **constructor** – A pointer to a method (function or class constructor) returning a QGraphicsItem based object. “constructor” method is expected to receive a node instance as the first argument. The rest of arguments passed to Item-Face are optional and will passed also to the constructor function.

3.2.4 Color names

SVG_COLORS

Apart from RGB color codes, the following SVG color names are supported:

Red colors			Green colors			Brown colors		
IndianRed	CD 5C 5C	205 92 92	GreenYellow	AD FF 2F	173 255 47	Cornsilk	FF F8 DC	255 248 220
LightCoral	F0 80 80	240 128 128	Chartreuse	7F FF 00	127 255 0	BlanchedAlmond	FF EB CD	255 235 205
Salmon	FA 80 72	250 128 114	LawnGreen	7C FC 00	124 252 0	Bisque	FF E4 C4	255 228 196
DarkSalmon	E9 96 7A	233 150 122	Lime	00 FF 00	0 255 0	NavajoWhite	FF DE AD	255 222 173
LightSalmon	FF A0 7A	255 160 122	LimeGreen	32 CD 32	50 205 50	Wheat	F5 DE B3	245 222 179
Crimson	DC 14 3C	220 20 60	PaleGreen	98 FB 98	152 251 152	BurlyWood	DE B8 87	222 184 135
Red	FF 00 00	255 0 0	LightGreen	90 EE 90	144 238 144	Tan	D2 B4 8C	210 180 140
FireBrick	B2 22 22	178 34 34	MediumSpringGreen	00 FA 9A	0 250 154	RosyBrown	BC 8F 8F	188 143 143
DarkRed	8B 00 00	139 0 0	SpringGreen	00 FF 7F	0 255 127	SandyBrown	F4 A4 60	244 164 96
Pink colors			MediumSeaGreen	3C B3 71	60 179 113	Goldenrod	DA A5 20	218 165 32
Pink	FF C0 CB	255 192 203	SeaGreen	2E 8B 57	46 139 87	DarkGoldenrod	B8 86 0B	184 134 11
LightPink	FF B6 C1	255 182 193	ForestGreen	22 8B 22	34 139 34	Peru	CD 85 3F	205 133 63
HotPink	FF 69 B4	255 105 180	Green	00 80 00	0 128 0	Chocolate	D2 69 1E	210 105 30
DeepPink	FF 14 93	255 20 147	DarkGreen	00 64 00	0 100 0	SaddleBrown	8B 45 13	139 69 19
MediumVioletRed	C7 15 85	199 21 133	YellowGreen	9A CD 32	154 205 50	Sienna	A0 52 2D	160 82 45
PaleVioletRed	DB 70 93	219 112 147	OliveDrab	6B 8E 23	107 142 35	Brown	A5 2A 2A	165 42 42
Orange colors			Olive	80 80 00	128 128 0	Maroon	80 00 00	128 0 0
LightSalmon	FF A0 7A	255 160 122	DarkOliveGreen	55 6B 2F	85 107 47	White colors		
Coral	FF 7F 50	255 127 80	MediumAquamarine	66 CD AA	102 205 170	White	FF FF FF	255 255 255
Tomato	FF 63 47	255 99 71	DarkSeaGreen	8F BC 8F	143 188 143	Snow	FF FA FA	255 250 250
OrangeRed	FF 45 00	255 69 0	LightSeaGreen	20 B2 AA	32 178 170	Honeydew	F0 FF F0	240 255 240
DarkOrange	FF 8C 00	255 140 0	DarkCyan	00 8B 8B	0 139 139	MintCream	F5 FF FA	245 255 250
Orange	FF A5 00	255 165 0	Teal	00 80 80	0 128 128	Azure	F0 FF FF	240 255 255
Yellow colors			Blue/Cyan colors			AliceBlue	F0 F8 FF	240 248 255
Gold	FF D7 00	255 215 0	Aqua	00 FF FF	0 255 255	GhostWhite	F8 F8 FF	248 248 255
Yellow	FF FF 00	255 255 0	Cyan	00 FF FF	0 255 255	WhiteSmoke	F5 F5 F5	245 245 245
LightYellow	FF FF E0	255 255 224	LightCyan	E0 FF FF	224 255 255	Seashell	FF F5 EE	255 245 238
LemonChiffon	FF FA CD	255 250 205	PaleTurquoise	AF EE EE	175 238 238	Beige	F5 F5 DC	245 245 220
LightGoldenrodYellow	FA FA D2	250 250 210	Aquamarine	7F FF D4	127 255 212	OldLace	FD F5 E6	253 245 230
PapayaWhip	FF EF D5	255 239 213	Turquoise	40 E0 D0	64 224 208	FloralWhite	FF FA F0	255 250 240
Moccasin	FF E4 B5	255 228 181	MediumTurquoise	48 D1 CC	72 209 204	Ivory	FF FF F0	255 255 240
PeachPuff	FF DA B9	255 218 185	DarkTurquoise	00 CE D1	0 206 209	AntiqueWhite	FA EB D7	250 235 215
PaleGoldenrod	EE E8 AA	238 232 170	CadetBlue	5F 9E A0	95 158 160	Linen	FA F0 E6	250 240 230
Khaki	F0 E6 8C	240 230 140	SteelBlue	46 82 B4	70 130 180	LavenderBlush	FF F0 F5	255 240 245
DarkKhaki	BD B7 6B	189 183 107	LightSteelBlue	B0 C4 DE	176 196 222	MistyRose	FF E4 E1	255 228 225
Purple colors			PowderBlue	B0 E0 E6	176 224 230	Gray colors		
Lavender	E6 E6 FA	230 230 250	LightBlue	AD D8 E6	173 216 230	Gainsboro	DC DC DC	220 220 220
Thistle	D8 BF D8	216 191 216	SkyBlue	87 CE EB	135 206 235	LightGrey	D3 D3 D3	211 211 211
Plum	DD A0 DD	221 160 221	LightSkyBlue	87 CE FA	135 206 250	Silver	C0 C0 C0	192 192 192
Violet	EE 82 EE	238 130 238	DeepSkyBlue	00 BF FF	0 191 255	DarkGray	A9 A9 A9	169 169 169
Orchid	DA 70 D6	218 112 214	DodgerBlue	1E 90 FF	30 144 255	Gray	80 80 80	128 128 128
Fuchsia	FF 00 FF	255 0 255	CornflowerBlue	64 95 ED	100 149 237	DimGray	69 69 69	105 105 105
Magenta	FF 00 FF	255 0 255	MediumSlateBlue	7B 68 EE	123 104 238	LightSlateGray	77 88 99	119 136 153
MediumOrchid	BA 55 D3	186 85 211	RoyalBlue	41 69 E1	65 105 225	SlateGray	70 80 90	112 128 144
BlueViolet	8A 2B E2	138 43 226	MediumBlue	00 00 CD	0 0 205	Black	00 00 00	0 0 0
DarkViolet	94 00 D3	148 0 211	DarkBlue	00 00 8B	0 0 139			
DarkOrchid	99 32 CC	153 50 204	Navy	00 00 80	0 0 128			
DarkMagenta	8B 00 8B	139 0 139	MidnightBlue	19 19 70	25 25 112			
Purple	80 00 80	128 0 128						
Indigo	4B 00 82	75 0 130						
SlateBlue	6A 5A CD	106 90 205						
DarkSlateBlue	48 3D 8B	72 61 139						
MediumSlateBlue	7B 68 EE	123 104 238						

COLOR_SCHEMES

random_color (*h=None, l=None, s=None, num=None, sep=None, seed=None*)

returns the RGB code of a random color. Hue (h), Lightness (l) and Saturation (s) of the generated color could be fixed using the pertinent function argument.

3.3 PhyloTree class

class PhyloNode (*newick=None, alignment=None, alg_format='fasta',
sp_naming_function=<function _parse_species>, format=0, **kargs*)

Bases: `ete2.coretype.tree.TreeNode`

Extends the standard *TreeNode* instance. It adds specific attributes and methods to work with phylogentic trees.

Parameters

- **newick** – Path to the file containing the tree or, alternatively, the text string containing the same information.
- **alignment** – file containing a multiple sequence alignment.
- **alg_format** – “fasta”, “phylip” or “iphylip” (interleaved)
- **format** – sub-newick format

FORMAT	DESCRIPTION
0	flexible with support values
1	flexible with internal node names
2	all branches + leaf names + internal supports
3	all branches + all names
4	leaf branches + leaf names
5	internal and leaf branches + leaf names
6	internal branches + leaf names
7	leaf branches + all names
8	all names
9	leaf names
100	topology only

- **sp_naming_function** – Pointer to a parsing python function that receives nodename as first argument and returns the species name (see *PhyloNode.set_species_naming_function()*). By default, the 3 first letter of nodes will be used as species identifiers.

Returns a tree node object which represents the base of the tree.

annotate_ncbi_taxa (*taxid_attr='species', tax2name=None, tax2track=None,
tax2rank=None, dbfile=None*)

Add NCBI taxonomy annotation to all descendant nodes. Leaf nodes are expected to contain a feature (name, by default) encoding a valid taxid number.

All descendant nodes (including internal nodes) are annotated with the following new features:

Node.spname: scientific species name as encoded in the NCBI taxonomy database

Node.named_lineage: the NCBI lineage track using scientific names

Node.taxid: NCBI taxid number

Node.lineage: same as *named_lineage* but using taxid codes.

Note that for internal nodes, NCBI information will refer to the first common lineage of the grouped species.

Parameters

- **taxid_attr** (*name*) – the name of the feature that should be used to access the taxid number associated to each node.
- **tax2name** (*None*) – A dictionary where keys are taxid numbers and

values are their translation into NCBI scientific name. Its use is optional and allows to avoid database queries when annotating many trees containing the same set of taxids.

Parameters tax2track (*None*) – A dictionary where keys are taxid numbers and

values are their translation into NCBI lineage tracks (taxids). Its use is optional and allows to avoid database queries when annotating many trees containing the same set of taxids.

Parameters tax2rank (*None*) – A dictionary where keys are taxid numbers and values are their translation into NCBI rank name. Its use is optional and allows to avoid database queries when annotating many trees containing the same set of taxids.

:param *None* *dbfile* : If provided, the provided file will be used as a local copy of the NCBI taxonomy database.

Returns *tax2name* (a dictionary translating taxid numbers into

scientific name), *tax2lineage* (a dictionary translating taxid numbers into their corresponding NCBI lineage track) and *tax2rank* (a dictionary translating taxid numbers into rank names).

collapse_lineage_specific_expansions (*species=None, return_copy=True*)

Converts lineage specific expansion nodes into a single tip node (randomly chosen from tips within the expansion).

Parameters species (*None*) – If supplied, only expansions matching the species criteria will be pruned. When *None*, all expansions within the tree will be processed.

get_age (*species2age*)

Implements the phylostratigraphic method described in:

Huerta-Cepas, J., & Gabaldon, T. (2011). Assigning duplication events to relative temporal scales in genome-wide studies. *Bioinformatics*, 27(1), 38-45.

get_age_balanced_outgroup (*species2age*)

New in version 2.2.

Returns the node better balance current tree structure according to the topological age of the different leaves and internal node sizes.

Parameters species2age – A dictionary translating from leaf names into a topological age.

get_descendant_evol_events (*sos_thr=0.0*)

Returns a list of **all** duplication and speciation events detected after this node. Nodes are as-

sumed to be duplications when a species overlap is found between its child lineages. Method is described more detail in:

“The Human Phylome.” Huerta-Cepas J, Dopazo H, Dopazo J, Gabaldon T. *Genome Biol.* 2007;8(6):R109.

get_farthest_oldest_leaf (*species2age, is_leaf_fn=None*)

Returns the farthest oldest leaf to the current one. It requires an *species2age* dictionary with the age estimation for all species.

Parameters *is_leaf_fn* (*None*) – A pointer to a function that receives a node instance as unique argument and returns True or False. It can be used to dynamically collapse nodes, so they are seen as leaves.

get_farthest_oldest_node (*species2age*)

New in version 2.1.

Returns the farthest oldest node (leaf or internal). The difference with *get_farthest_oldest_leaf()* is that in this function internal nodes grouping seqs from the same species are collapsed.

get_my_evol_events (*sos_thr=0.0*)

Returns a list of duplication and speciation events in which the current node has been involved. Scanned nodes are also labeled internally as *dup=True/False*. You can access this labels using the ‘*node.dup*’ syntaxis.

Method: the algorithm scans all nodes from the given *leafName* to the root. Nodes are assumed to be duplications when a species overlap is found between its child lineages. Method is described more detail in:

“The Human Phylome.” Huerta-Cepas J, Dopazo H, Dopazo J, Gabaldon T. *Genome Biol.* 2007;8(6):R109.

get_speciation_trees (*map_features=None, autodetect_duplications=True, newick_only=False, target_attr='species'*)

Calculates all possible species trees contained within a duplicated gene family tree as described in [Treeko](#) (see [Marcet and Gabaldon, 2011](#)).

Parameters *autodetect_duplications* (*True*) – If True, duplication nodes will be automatically detected using the Species Overlap algorithm (*PhyloNode.get_descendants_evol_events()*). If False, duplication nodes within the original tree are expected to contain the feature “*evoltype=D*”.

Parameters *features* (*None*) – A list of features that should be mapped from the original gene family tree to each species tree subtree.

Returns (*number_of_sptrees, number_of_dups, species_tree_iterator*)

get_species ()

Returns the set of species covered by its partition.

iter_species ()

Returns an iterator over the species grouped by this node.

link_to_alignment (*alignment, alg_format='fasta', **kwargs*)

ncbi_compare (*autodetect_duplications=True, cached_content=None*)

reconcile (*species_tree*)

Returns the reconciled topology with the provided species tree, and a list of evolutionary events inferred from such reconciliation.

set_species_naming_function (*fn*)

Sets the parsing function used to extract species name from a node's name.

Parameters *fn* – Pointer to a parsing python function that receives nodename as first argument and returns the species name.

```
# Example of a parsing function to extract species names for
# all nodes in a given tree.
def parse_sp_name(node_name):
    return node_name.split("_")[1]
tree.set_species_naming_function(parse_sp_name)
```

species

split_by_dups (*autodetect_duplications=True*)

Returns the list of all subtrees resulting from splitting current tree by its duplication nodes.

Parameters *autodetect_duplications* (*True*) – If True, duplication

nodes will be automatically detected using the Species Overlap algorithm (`PhyloNode.get_descendants_evolution_events()`). If False, duplication nodes within the original tree are expected to contain the feature “*evolution=D*”.

Returns *species_trees*

PhyloTree

alias of *PhyloNode*

class EvolEvent

Basic evolutionary event. It stores all the information about an event(node) occurred in a phylogenetic tree.

etype : D (Duplication), S (Speciation), L (gene loss),

in_seqs : the list of sequences in one side of the event.

out_seqs : the list of sequences in the other side of the event

node : link to the event node in the tree

Contents

- *Clustering module*

3.4 Clustering module

class ClusterNode (*newick=None, text_array=None, fdist=<function spearman_dist>*)

Bases: `ete2.coretype.tree.TreeNode`

Creates a new Cluster Tree object, which is a collection of ClusterNode instances connected in a hierarchical way, and representing a clustering result.

a newick file or string can be passed as the first argument. An ArrayTable file or instance can be passed as a second argument.

Examples: `t1 = Tree()` # creates an empty tree `t2 = Tree('(A:1,(B:1,(C:1,D:1):0.5):0.5);')` `t3 = Tree('/home/user/myNewickFile.txt')`

get_dunn (*clusters, fdist=None*)

Calculates the Dunn index for the given set of descendant nodes.

get_leaf_profiles ()

Returns the list of all the profiles associated to the leaves under this node.

get_silhouette (*fdist=None*)

Calculates the node's silhouette value by using a given distance function. By default, euclidean distance is used. It also calculates the deviation profile, mean profile, and inter/intra-cluster distances.

It sets the following features into the analyzed node:

- `node.intracluster`
- `node.intercluster`
- `node.silhouette`

intracluster distances $a(i)$ are calculated as the Centroid Diameter

intercluster distances $b(i)$ are calculated as the Centroid linkage distance

** Rousseeuw, P.J. (1987) Silhouettes: A graphical aid to the interpretation and validation of cluster analysis. *J. Comput. Appl. Math.*, 20, 53-65.

iter_leaf_profiles ()

Returns an iterator over all the profiles associated to the leaves under this node.

link_to_arraytable (*arraytbl*)

Allows to link a given arraytable object to the tree structure under this node. Row names in the arraytable object are expected to match leaf names.

Returns a list of nodes for which profiles could not be found in arraytable.

set_distance_function (*fn*)

Sets the distance function used to calculate cluster distances and silhouette index.

ARGUMENTS:

fn: a pointer to python function accepting two arrays (numpy) as arguments.

EXAMPLE:

```
# A simple euclidean distance my_dist_fn = lambda x,y: abs(x-y)
tree.set_distance_function(my_dist_fn)
```

ClusterTree

alias of *ClusterNode*

New in version 2.1.

3.5 Nexml module

3.5.1 Nexml classes linked to ETE

class Nexml (**args, **kwargs*)

Creates a new nexml project.

build_from_file (*fname, index_otus=True*)

Populate Nexml project with data in a nexml file.

class NexmlTree (*newick=None, alignment=None, alg_format='fasta',
sp_naming_function=<function _parse_species>, format=0*)

Special PhyloTree object with nexml support

3.5.2 Generic Nexml classes

class AAChar (*about=None, meta=None, label=None, id=None, tokens=None, states=None,
codon=None, valueOf_=None*)

A concrete implementation of the AbstractChar element.

superclass

alias of AbstractChar

class AAFormat (*about=None, meta=None, states=None, char=None, set=None, val-
ueOf_=None*)

The AAFormat class is the container of amino acid column definitions.

superclass

alias of AbstractFormat

class AAMapping (*state=None, valueOf_=None*)

An IUPAC ambiguity mapping.

superclass

alias of AbstractMapping

class AAMatrixObsRow (*about=None, meta=None, label=None, id=None, otu=None,
cell=None, set=None, valueOf_=None*)

This is a row in a matrix of amino acid data containing granular observations.

superclass

alias of AbstractObsRow

class AAMatrixSeqRow (*about=None, meta=None, label=None, id=None, otu=None,
seq=None, valueOf_=None*)

This is a row in a matrix of amino acid data containing raw sequence data.

superclass

alias of AbstractSeqRow

class AAObs (*about=None, meta=None, label=None, char=None, state=None, val-
ueOf_=None*)

This is a single cell in a matrix containing an amino acid observation.

superclass

alias of AbstractObs

class AAObsMatrix (*about=None, meta=None, row=None, set=None, valueOf_=None*)

A matrix of rows with single character observations.

superclass

alias of AbstractObsMatrix

class AAPolymorphicStateSet (*about=None, meta=None, label=None, id=None, symbol=None, member=None, uncertain_state_set=None, valueOf_=None*)

The AAPolymorphicStateSet defines a polymorphic ambiguity mapping.

superclass

alias of AbstractPolymorphicStateSet

class AASeqMatrix (*about=None, meta=None, row=None, set=None, valueOf_=None*)

A matrix of rows with amino acid data as sequence strings.

superclass

alias of AbstractSeqMatrix

class AAState (*about=None, meta=None, label=None, id=None, symbol=None, valueOf_=None*)

This is a concrete implementation of the state element, which requires a symbol element, in this case restricted to AAToken, i.e. a single IUPAC amino acid symbol, and optional mapping elements to refer to other states.

superclass

alias of AbstractState

class AAStates (*about=None, meta=None, label=None, id=None, state=None, polymorphic_state_set=None, uncertain_state_set=None, set=None, valueOf_=None*)

A container for a set of states.

superclass

alias of AbstractStates

class AAUncertainStateSet (*about=None, meta=None, label=None, id=None, symbol=None, member=None, valueOf_=None*)

The AAUncertainStateSet defines an uncertain ambiguity mapping.

superclass

alias of AbstractUncertainStateSet

class AbstractBlock (*about=None, meta=None, label=None, id=None, otus=None, format=None, valueOf_=None*)

The AbstractBlock is the superclass for blocks that contain an element structure of type AbstractFormat.

superclass

alias of TaxaLinked

class AbstractCells (*about=None, meta=None, label=None, id=None, otus=None, format=None, matrix=None, valueOf_=None*)

The AbstractSeqBlock type is the superclass for character blocks that consist of granular character state observations.

superclass

alias of AbstractBlock

class AbstractChar (*about=None, meta=None, label=None, id=None, tokens=None, states=None, codon=None, valueOf_=None*)

The AbstractChar type is the superclass for a column definition, which may have a “states” attribute that refers to an AbstractStates element, a codon attribute of type CodonPosition and an id attribute that may be an actual id (e.g. for categorical matrices where observations explicitly refer to a column definition) or an integer for sequence matrices.

superclass

alias of IDTagged

class AbstractEdge (*about=None, meta=None, label=None, id=None, source=None, length=None, target=None, valueOf_=None*)

The AbstractEdge superclass is what concrete edges inherit from by restriction. It represents an edge element much like that of GraphML, i.e. an element that connects node elements.

superclass

alias of IDTagged

class AbstractFormat (*about=None, meta=None, states=None, char=None, set=None, valueOf_=None*)

The AbstractFormat type is the superclass for the element that defines the allowed characters and states in a matrix, and their ambiguity mapping. It may enclose AbstractStates elements that define states and their mappings, and AbstractChar elements that specify which AbstractStates apply to which matrix columns.

superclass

alias of Annotated

class AbstractMapping (*state=None, valueOf_=None*)

The AbstractMapping type is the superclass for an ambiguity mapping. In an instance document, a subclass of this type will look like <member state=“st1”/>, i.e. an element called “member” with an attribute called “state” whose value is an id reference that refers to an element that subclasses AbstractState. The purpose of AbstractMapping is to specify which other states may be implied, e.g. a nucleotide symbol “N” would have mappings to “A”, “C”, “G” and “T”.

superclass

alias of Base

class AbstractNetwork (*about=None, meta=None, label=None, id=None, node=None, edge=None, set=None, valueOf_=None*)

The AbstractNetwork superclass is what a concrete network inherits from.

superclass

alias of IDTagged

class AbstractNode (*about=None, meta=None, label=None, id=None, otu=None, root=False, valueOf_=None*)

The AbstractNode superclass is what concrete nodes inherit from by restriction. It represents a node element much like that of GraphML, i.e. an element that is connected into a tree by edge elements.

superclass

alias of OptionalTaxonLinked

class AbstractObs (*about=None, meta=None, label=None, char=None, state=None, valueOf_=None*)

The AbstractObs type is the superclass for single observations, i.e. cells in a matrix. A concrete instance of AbstractObs has a “char” attribute that refers to an explicitly defined character (e.g. in

categorical matrices), and a “state” attribute that either holds a reference to an explicitly defined state, or a raw state value (a continuous value).

superclass

alias of `Labelled`

class `AbstractObsMatrix` (*about=None, meta=None, row=None, set=None, valueOf_=None*)

The `AbstractObsMatrix` super class is the abstract type for a <matrix> element that contains rows which hold granular state observations.

superclass

alias of `Annotated`

class `AbstractObsRow` (*about=None, meta=None, label=None, id=None, otu=None, cell=None, set=None, valueOf_=None*)

The `AbstractObsRow` represents a single row in a matrix. The row must refer to a previously declared otu element by its id attribute (and must have an id itself, may have a label, and may have meta attachments). The row contains multiple cell elements.

superclass

alias of `TaxonLinked`

class `AbstractPolymorphicStateSet` (*about=None, meta=None, label=None, id=None, symbol=None, member=None, uncertain_state_set=None, valueOf_=None*)

The `AbstractPolymorphicStateSet` type is the super-class for a polymorphic state set definition. The element has a required `AbstractSymbol` attribute that in restricted concrete subclasses must be of a sensible type such as a single IUPAC character. It may enclose zero or more `AbstractMapping` elements to resolve ambiguities.

superclass

alias of `AbstractUncertainStateSet`

class `AbstractRootEdge` (*about=None, meta=None, label=None, id=None, length=None, target=None, valueOf_=None*)

The `AbstractRootEdge` complex type is a superclass for the edge that leads into a root, i.e. an edge with only a target attribute, but no source attribute. This type of edge is used for coalescent trees, where the initial lineage has a certain length before things start splitting up.

superclass

alias of `IDTagged`

class `AbstractSeqMatrix` (*about=None, meta=None, row=None, set=None, valueOf_=None*)

The `AbstractSeqMatrix` super class is the abstract type for a <matrix> element that contains rows which hold raw character sequences.

superclass

alias of `Annotated`

class `AbstractSeqRow` (*about=None, meta=None, label=None, id=None, otu=None, seq=None, valueOf_=None*)

The `AbstractSeqRow` represents a single row in a matrix. The row must refer to a previously declared otu element by its id attribute (and must have an id itself, may have a label, and may have meta attachments). The row contains a single seq element with raw character data.

superclass

alias of `TaxonLinked`

class AbstractSeqs (*about=None, meta=None, label=None, id=None, otus=None, format=None, matrix=None, valueOf_=None*)

The AbstractSeqBlock type is the superclass for character blocks that consist of raw character sequences.

superclass

alias of AbstractBlock

class AbstractState (*about=None, meta=None, label=None, id=None, symbol=None, valueOf_=None*)

The AbstractState type is the super-class for a state definition. The element has a required symbol attribute that in restricted concrete subclasses must be of a sensible type such as a single IUPAC character. It may enclose zero or more AbstractMapping elements to resolve ambiguities.

superclass

alias of IDTagged

class AbstractStates (*about=None, meta=None, label=None, id=None, state=None, polymorphic_state_set=None, uncertain_state_set=None, set=None, valueOf_=None*)

A container for a set of AbstractState elements.

superclass

alias of IDTagged

class AbstractTree (*about=None, meta=None, label=None, id=None, node=None, root-edge=None, edge=None, set=None, valueOf_=None*)

The AbstractTree superclass is what a concrete tree inherits from.

superclass

alias of IDTagged

class AbstractTrees (*about=None, meta=None, label=None, id=None, network=None, tree=None, set=None, valueOf_=None*)

The AbstractTrees superclass is what concrete trees inherit from.

superclass

alias of IDTagged

class AbstractUncertainStateSet (*about=None, meta=None, label=None, id=None, symbol=None, member=None, valueOf_=None*)

The AbstractUncertainStateSet type is the super-class for an uncertain state set definition. The element has a required AbstractSymbol attribute that in restricted concrete subclasses must be of a sensible type such as a single IUPAC character. It may enclose zero or more AbstractMapping elements to resolve ambiguities.

superclass

alias of AbstractState

class Annotated (*about=None, meta=None, valueOf_=None*)

The Annotated complexType is a super class for objects that optionally have metadata annotations of type Meta.

superclass

alias of Base

class Base (*valueOf_=None*)

The base type for all complexType definitions in the nexml schema. This type allows a number of special attributes: xml:lang - for languages codes xml:base - see <http://www.w3.org/TR/xmlbase/>

xml:id - see <http://www.w3.org/TR/xml-id/> xml:space - for whitespace handling xlink:href - for links Also see <http://www.w3.org/2001/xml.xsd> for more information on the xml and xlink attributes.

class ContinuousCells (*about=None, meta=None, label=None, id=None, otus=None, format=None, matrix=None, valueOf_=None*)

A continuous characters block consisting of granular cells preceded by metadata.

superclass

alias of AbstractCells

class ContinuousChar (*about=None, meta=None, label=None, id=None, tokens=None, states=None, codon=None, valueOf_=None*)

A concrete implementation of the char element, which requires only an id attribute.

superclass

alias of AbstractChar

class ContinuousFormat (*about=None, meta=None, states=None, char=None, set=None, valueOf_=None*)

The ContinuousFormat class is the container of continuous column definitions.

superclass

alias of AbstractFormat

class ContinuousMatrixObsRow (*about=None, meta=None, label=None, id=None, otu=None, cell=None, set=None, valueOf_=None*)

This is a row in a matrix of continuous data as granular observations.

superclass

alias of AbstractObsRow

class ContinuousMatrixSeqRow (*about=None, meta=None, label=None, id=None, otu=None, seq=None, valueOf_=None*)

This is a row in a matrix of continuous data as character sequences.

superclass

alias of AbstractSeqRow

class ContinuousObs (*about=None, meta=None, label=None, char=None, state=None, valueOf_=None*)

This is a single cell in a matrix containing a continuous observation.

superclass

alias of AbstractObs

class ContinuousObsMatrix (*about=None, meta=None, row=None, set=None, valueOf_=None*)

A matrix of rows with single character observations.

superclass

alias of AbstractObsMatrix

class ContinuousSeqMatrix (*about=None, meta=None, row=None, set=None, valueOf_=None*)

A matrix of rows with seq strings of type continuous.

superclass

alias of AbstractSeqMatrix

class ContinuousSeqs (*about=None, meta=None, label=None, id=None, otus=None, format=None, matrix=None, valueOf_=None*)

A continuous characters block consisting of float sequences preceded by metadata.

superclass

alias of AbstractSeqs

class DNACChar (*about=None, meta=None, label=None, id=None, tokens=None, states=None, codon=None, valueOf_=None*)

A concrete implementation of the AbstractChar element.

superclass

alias of AbstractChar

class DNAFormat (*about=None, meta=None, states=None, char=None, set=None, valueOf_=None*)

The DNAFormat class is the container of DNA column definitions.

superclass

alias of AbstractFormat

class DNAMapping (*state=None, valueOf_=None*)

An IUPAC ambiguity mapping.

superclass

alias of AbstractMapping

class DNAMatrixObsRow (*about=None, meta=None, label=None, id=None, otu=None, cell=None, set=None, valueOf_=None*)

This is a row in a matrix of DNA data containing granular observations.

superclass

alias of AbstractObsRow

class DNAMatrixSeqRow (*about=None, meta=None, label=None, id=None, otu=None, seq=None, valueOf_=None*)

This is a row in a matrix of DNA data containing raw sequence data.

superclass

alias of AbstractSeqRow

class DNAObs (*about=None, meta=None, label=None, char=None, state=None, valueOf_=None*)

This is a single cell in a matrix containing a nucleotide observation.

superclass

alias of AbstractObs

class DNAObsMatrix (*about=None, meta=None, row=None, set=None, valueOf_=None*)

A matrix of rows with single character observations.

superclass

alias of AbstractObsMatrix

class DNAPolymorphicStateSet (*about=None, meta=None, label=None, id=None, symbol=None, member=None, uncertain_state_set=None, valueOf_=None*)

The DNAPolymorphicStateSet type defines an IUPAC ambiguity mapping. It may enclose zero or more AbstractMapping elements to resolve ambiguities.

superclass

alias of AbstractPolymorphicStateSet

class DNASeqMatrix (*about=None, meta=None, row=None, set=None, valueOf_=None*)

A matrix of rows with seq strings of type DNA.

superclass

alias of AbstractSeqMatrix

class DNASTate (*about=None, meta=None, label=None, id=None, symbol=None, valueOf_=None*)

This is a concrete implementation of the state element, which requires a symbol element, in this case restricted to DNAToken, i.e. a single IUPAC nucleotide symbol, and optional mapping elements to refer to other states.

superclass

alias of AbstractState

class DNASTates (*about=None, meta=None, label=None, id=None, state=None, polymorphic_state_set=None, uncertain_state_set=None, set=None, valueOf_=None*)

A container for a set of states.

superclass

alias of AbstractStates

class DNAUncertainStateSet (*about=None, meta=None, label=None, id=None, symbol=None, member=None, valueOf_=None*)

The DNAUncertainStateSet type defines an IUPAC ambiguity mapping. It may enclose zero or more AbstractMapping elements to resolve ambiguities.

superclass

alias of AbstractUncertainStateSet

class DnaCells (*about=None, meta=None, label=None, id=None, otus=None, format=None, matrix=None, valueOf_=None*)

A DNA characters block consisting of granular cells preceded by metadata.

superclass

alias of AbstractCells

class DnaSeqs (*about=None, meta=None, label=None, id=None, otus=None, format=None, matrix=None, valueOf_=None*)

A DNA characters block consisting of sequences preceded by metadata.

superclass

alias of AbstractSeqs

class FloatNetwork (*about=None, meta=None, label=None, id=None, node=None, edge=None, set=None, valueOf_=None*)

A concrete network implementation, with floating point edge lengths.

superclass

alias of AbstractNetwork

class FloatTree (*about=None, meta=None, label=None, id=None, node=None, root-edge=None, edge=None, set=None, valueOf_=None*)

A concrete tree implementation, with floating point edge lengths.

subclass

alias of NexmlTree

superclass

alias of `AbstractTree`

class `IDTagged` (*about=None, meta=None, label=None, id=None, valueOf_=None*)

The `IDTagged` complexType is a super class for objects that require unique id attributes of type `xs:ID`. The id must be unique within the XML document.

superclass

alias of `Labelled`

class `IntNetwork` (*about=None, meta=None, label=None, id=None, node=None, edge=None, set=None, valueOf_=None*)

A concrete network implementation, with integer edge lengths.

superclass

alias of `AbstractNetwork`

class `IntTree` (*about=None, meta=None, label=None, id=None, node=None, rootedge=None, edge=None, set=None, valueOf_=None*)

A concrete tree implementation, with integer edge lengths.

subclass

alias of `NexmlTree`

superclass

alias of `AbstractTree`

class `Labelled` (*about=None, meta=None, label=None, valueOf_=None*)

The `Labelled` complexType is a super class for objects that optionally have label attributes to use as a (non-unique) name of type `xs:string`.

superclass

alias of `Annotated`

class `LiteralMeta` (*datatype=None, content=None, property=None, valueOf_=None*)

Metadata annotations in which the object is a literal value. If the `@content` attribute is used, then the element should contain no children.

class `NetworkFloatEdge` (*about=None, meta=None, label=None, id=None, source=None, length=None, target=None, valueOf_=None*)

A concrete network edge implementation, with float edge.

superclass

alias of `AbstractEdge`

class `NetworkIntEdge` (*about=None, meta=None, label=None, id=None, source=None, length=None, target=None, valueOf_=None*)

A concrete network edge implementation, with int edge.

superclass

alias of `AbstractEdge`

class `NetworkNode` (*about=None, meta=None, label=None, id=None, otu=None, root=False, valueOf_=None*)

A concrete network node implementation.

superclass

alias of `AbstractNode`

class `Nexml` (**args, **kargs*)

Creates a new nexml project.

build_from_file (*fname, index_otus=True*)
 Populate Nexml project with data in a nexml file.

class OptionalTaxonLinked (*about=None, meta=None, label=None, id=None, otu=None, valueOf_=None*)
 The OptionalOTULinked complexType is a super class for objects that that optionally have an otu id reference.

superclass
 alias of IDTagged

class ProteinCells (*about=None, meta=None, label=None, id=None, otus=None, format=None, matrix=None, valueOf_=None*)
 An amino acid characters block consisting of granular cells preceded by metadata.

superclass
 alias of AbstractCells

class ProteinSeqs (*about=None, meta=None, label=None, id=None, otus=None, format=None, matrix=None, valueOf_=None*)
 An amino acid characters block consisting of sequences preceded by metadata.

superclass
 alias of AbstractSeqs

class RNACChar (*about=None, meta=None, label=None, id=None, tokens=None, states=None, codon=None, valueOf_=None*)
 A concrete implementation of the AbstractChar element, i.e. a single column in an alignment.

superclass
 alias of AbstractChar

class RNAFormat (*about=None, meta=None, states=None, char=None, set=None, valueOf_=None*)
 The RNAFormat class is the container of RNA column definitions.

superclass
 alias of AbstractFormat

class RNAMapping (*state=None, valueOf_=None*)
 An IUPAC RNA ambiguity mapping.

superclass
 alias of AbstractMapping

class RNAMatrixObsRow (*about=None, meta=None, label=None, id=None, otu=None, cell=None, set=None, valueOf_=None*)
 This is a row in a matrix of RNA data containing granular observations.

superclass
 alias of AbstractObsRow

class RNAMatrixSeqRow (*about=None, meta=None, label=None, id=None, otu=None, seq=None, valueOf_=None*)
 This is a row in a matrix of RNA data containing raw sequence data.

superclass
 alias of AbstractSeqRow

class RNAObs (*about=None, meta=None, label=None, char=None, state=None, valueOf_=None*)

This is a single cell in a matrix containing an RNA nucleotide observation.

superclass

alias of AbstractObs

class RNAObsMatrix (*about=None, meta=None, row=None, set=None, valueOf_=None*)

A matrix of rows with single character observations.

superclass

alias of AbstractObsMatrix

class RNAPolymorphicStateSet (*about=None, meta=None, label=None, id=None, symbol=None, member=None, uncertain_state_set=None, valueOf_=None*)

The RNAPolymorphicStateSet describes a single polymorphic IUPAC ambiguity mapping.

superclass

alias of AbstractPolymorphicStateSet

class RNASeqMatrix (*about=None, meta=None, row=None, set=None, valueOf_=None*)

A matrix of rows with seq strings of type RNA.

superclass

alias of AbstractSeqMatrix

class RNAState (*about=None, meta=None, label=None, id=None, symbol=None, valueOf_=None*)

This is a concrete implementation of the state element, which requires a symbol attribute, in this case restricted to RNAToken, i.e. a single IUPAC nucleotide symbol, and optional mapping elements to refer to other states.

superclass

alias of AbstractState

class RNASStates (*about=None, meta=None, label=None, id=None, state=None, polymorphic_state_set=None, uncertain_state_set=None, set=None, valueOf_=None*)

A container for a set of states.

superclass

alias of AbstractStates

class RNAUncertainStateSet (*about=None, meta=None, label=None, id=None, symbol=None, member=None, valueOf_=None*)

The RNAUncertainStateSet describes a single uncertain IUPAC ambiguity mapping.

superclass

alias of AbstractUncertainStateSet

class ResourceMeta (*href=None, rel=None, meta=None, valueOf_=None*)

Metadata annotations in which the object is a resource. If this element contains meta elements as children, then the object of this annotation is a “blank node”.

class RestrictionCells (*about=None, meta=None, label=None, id=None, otus=None, format=None, matrix=None, valueOf_=None*)

A standard characters block consisting of granular cells preceded by metadata.

superclass
alias of `AbstractCells`

class RestrictionChar (*about=None, meta=None, label=None, id=None, tokens=None, states=None, codon=None, valueOf_=None*)
A concrete implementation of the char element, which requires a unique identifier and a state set reference.

superclass
alias of `AbstractChar`

class RestrictionFormat (*about=None, meta=None, states=None, char=None, set=None, valueOf_=None*)
The `RestrictionFormat` class is the container of restriction column definitions.

superclass
alias of `AbstractFormat`

class RestrictionMatrixObsRow (*about=None, meta=None, label=None, id=None, otu=None, cell=None, set=None, valueOf_=None*)
This is a row in a matrix of restriction site data as granular observations.

superclass
alias of `AbstractObsRow`

class RestrictionMatrixSeqRow (*about=None, meta=None, label=None, id=None, otu=None, seq=None, valueOf_=None*)
This is a row in a matrix of restriction site data as character sequences.

superclass
alias of `AbstractSeqRow`

class RestrictionObs (*about=None, meta=None, label=None, char=None, state=None, valueOf_=None*)
This is a single cell in a matrix containing a restriction site observation.

superclass
alias of `AbstractObs`

class RestrictionObsMatrix (*about=None, meta=None, row=None, set=None, valueOf_=None*)
A matrix of rows with single character observations.

superclass
alias of `AbstractObsMatrix`

class RestrictionSeqMatrix (*about=None, meta=None, row=None, set=None, valueOf_=None*)
A matrix of rows with seq strings of type restriction.

superclass
alias of `AbstractSeqMatrix`

class RestrictionSeqs (*about=None, meta=None, label=None, id=None, otus=None, format=None, matrix=None, valueOf_=None*)
A restriction site characters block consisting of sequences preceded by metadata.

superclass
alias of `AbstractSeqs`

class RestrictionState (*about=None, meta=None, label=None, id=None, symbol=None, valueOf_=None*)

This is a concrete implementation of the state element, which requires a symbol element, in this case restricted to 0/1.

superclass

alias of `AbstractState`

class RestrictionStates (*about=None, meta=None, label=None, id=None, state=None, polymorphic_state_set=None, uncertain_state_set=None, set=None, valueOf_=None*)

A container for a set of states.

superclass

alias of `AbstractStates`

class RnaCells (*about=None, meta=None, label=None, id=None, otus=None, format=None, matrix=None, valueOf_=None*)

A RNA characters block consisting of granular cells preceded by metadata.

superclass

alias of `AbstractCells`

class RnaSeqs (*about=None, meta=None, label=None, id=None, otus=None, format=None, matrix=None, valueOf_=None*)

A RNA characters block consisting of sequences preceded by metadata.

superclass

alias of `AbstractSeqs`

class StandardCells (*about=None, meta=None, label=None, id=None, otus=None, format=None, matrix=None, valueOf_=None*)

A standard characters block consisting of granular cells preceded by metadata.

superclass

alias of `AbstractCells`

class StandardChar (*about=None, meta=None, label=None, id=None, tokens=None, states=None, codon=None, valueOf_=None*)

A concrete implementation of the char element, which requires a states attribute to refer to a set of defined states

superclass

alias of `AbstractChar`

class StandardFormat (*about=None, meta=None, states=None, char=None, set=None, valueOf_=None*)

The StandardFormat class is the container of standard column definitions.

superclass

alias of `AbstractFormat`

class StandardMapping (*state=None, valueOf_=None*)

A standard character ambiguity mapping.

superclass

alias of `AbstractMapping`

class StandardMatrixObsRow (*about=None, meta=None, label=None, id=None, otu=None, cell=None, set=None, valueOf_=None*)

This is a row in a matrix of standard data as granular observations.

superclass

alias of `AbstractObsRow`

class `StandardMatrixSeqRow` (*about=None, meta=None, label=None, id=None, otu=None, seq=None, valueOf_=None*)

This is a row in a matrix of standard data as character sequences.

superclass

alias of `AbstractSeqRow`

class `StandardObs` (*about=None, meta=None, label=None, char=None, state=None, valueOf_=None*)

This is a single cell in a matrix containing a standard observation.

superclass

alias of `AbstractObs`

class `StandardObsMatrix` (*about=None, meta=None, row=None, set=None, valueOf_=None*)

A matrix of rows with single character observations.

superclass

alias of `AbstractObsMatrix`

class `StandardPolymorphicStateSet` (*about=None, meta=None, label=None, id=None, symbol=None, member=None, uncertain_state_set=None, valueOf_=None*)

The `StandardPolymorphicStateSet` type is a single polymorphic ambiguity mapping.

superclass

alias of `AbstractPolymorphicStateSet`

class `StandardSeqMatrix` (*about=None, meta=None, row=None, set=None, valueOf_=None*)

A matrix of rows with seq strings of type standard.

superclass

alias of `AbstractSeqMatrix`

class `StandardSeqs` (*about=None, meta=None, label=None, id=None, otus=None, format=None, matrix=None, valueOf_=None*)

A standard characters block consisting of sequences preceded by metadata.

superclass

alias of `AbstractSeqs`

class `StandardState` (*about=None, meta=None, label=None, id=None, symbol=None, valueOf_=None*)

This is a concrete implementation of the state element, which requires a symbol element, in this case restricted to integers, and optional mapping elements to refer to other states.

superclass

alias of `AbstractState`

class `StandardStates` (*about=None, meta=None, label=None, id=None, state=None, polymorphic_state_set=None, uncertain_state_set=None, set=None, valueOf_=None*)

A container for a set of states.

superclass

alias of `AbstractStates`

class StandardUncertainStateSet (*about=None, meta=None, label=None, id=None, symbol=None, member=None, valueOf_=None*)

The StandardUncertainStateSet type is a single uncertain ambiguity mapping.

superclass

alias of AbstractUncertainStateSet

class TaxaLinked (*about=None, meta=None, label=None, id=None, otus=None, valueOf_=None*)

The TaxaLinked complexType is a super class for objects that that require an otus id reference.

superclass

alias of IDTagged

class TaxonLinked (*about=None, meta=None, label=None, id=None, otu=None, valueOf_=None*)

The TaxonLinked complexType is a super class for objects that require a taxon id reference.

superclass

alias of IDTagged

class TreeFloatEdge (*about=None, meta=None, label=None, id=None, source=None, length=None, target=None, valueOf_=None*)

A concrete edge implementation, with float length.

superclass

alias of AbstractEdge

class TreeFloatRootEdge (*about=None, meta=None, label=None, id=None, length=None, target=None, valueOf_=None*)

A concrete root edge implementation, with float length.

superclass

alias of AbstractRootEdge

class TreeIntEdge (*about=None, meta=None, label=None, id=None, source=None, length=None, target=None, valueOf_=None*)

A concrete edge implementation, with int length.

superclass

alias of AbstractEdge

class TreeIntRootEdge (*about=None, meta=None, label=None, id=None, length=None, target=None, valueOf_=None*)

A concrete root edge implementation, with int length.

superclass

alias of AbstractRootEdge

class TreeNode (*about=None, meta=None, label=None, id=None, otu=None, root=False, valueOf_=None*)

A concrete node implementation.

superclass

alias of AbstractNode

class Trees (*about=None, meta=None, label=None, id=None, otus=None, network=None, tree=None, set=None, valueOf_=None*)

A concrete container for tree objects.

superclass

alias of TaxaLinked

class attrExtensions (*valueOf_=None*)

This element is for use in WSDL 1.1 only. It does not apply to WSDL 2.0 documents. Use in WSDL 2.0 documents is invalid.

class Nexml (**args, **kargs*)

Creates a new nexml project.

build_from_file (*fname, index_otus=True*)

Populate Nexml project with data in a nexml file.

class NexmlTree (*newick=None, alignment=None, alg_format='fasta',
sp_naming_function=<function _parse_species>, format=0*)

Special PhyloTree object with nexml support

New in version 2.1.

3.6 Phyloxml Module

3.6.1 Phyloxml classes linked to ETE

class Phyloxml (**args, **kargs*)

class PhyloxmlTree (*phyloxml_clade=None, phyloxml_phylogeny=None, **kargs*)

PhyloTree object supporting phyloXML format.

3.6.2 Generic Phyloxml classes

class Accession (*source=None, valueOf_=None*)

Element Accession is used to capture the local part in a sequence identifier (e.g. 'P17304' in 'UniProtKB:P17304', in which case the 'source' attribute would be 'UniProtKB').

class Annotation (*source=None, type_=None, ref=None, evidence=None, desc=None, confidence=None, property=None, uri=None, valueOf_=None*)

The annotation of a molecular sequence. It is recommended to annotate by using the optional 'ref' attribute (some examples of acceptable values for the ref attribute: 'GO:0008270', 'KEGG:Tetrachloroethene degradation', 'EC:1.1.1.1'). Optional element 'desc' allows for a free text description. Optional element 'confidence' is used to state the type and value of support for an annotation. Similarly, optional attribute 'evidence' is used to describe the evidence for an annotation as free text (e.g. 'experimental'). Optional element 'property' allows for further, typed and referenced annotations from external resources.

class BinaryCharacters (*lost_count=None, absent_count=None, present_count=None,
type_=None, gained_count=None, gained=None, lost=None,
present=None, absent=None, valueOf_=None*)

The names and/or counts of binary characters present, gained, and lost at the root of a clade.

class BranchColor (*red=None, green=None, blue=None, valueOf_=None*)

This indicates the color of a clade when rendered (the color applies to the whole clade unless overwritten by the color(s) of sub clades).

class Clade (*id_source=None, branch_length_attr=None, name=None, branch_length=None,
confidence=None, width=None, color=None, node_id=None, taxonomy=None,
sequence=None, events=None, binary_characters=None, distribution=None,
date=None, reference=None, property=None, clade=None, valueOf_=None*)

Element Clade is used in a recursive manner to describe the topology of a phylogenetic tree. The parent branch length of a clade can be described either with the 'branch_length' element or the 'branch_length' attribute (it is not recommended to use both at the same time, though). Usage of the 'branch_length' attribute allows for a less verbose description. Element 'confidence' is used to indicate the support for a clade/parent branch. Element 'events' is used to describe such events as gene-duplications at the root node/parent branch of a clade. Element 'width' is the branch width for this clade (including parent branch). Both 'color' and 'width' elements apply for the whole clade unless overwritten in-sub clades. Attribute 'id_source' is used to link other elements to a clade (on the xml-level).

class CladeRelation (*id_ref_0=None, id_ref_1=None, type_=None, distance=None, confidence=None, valueOf_=None*)

This is used to express a typed relationship between two clades. For example it could be used to describe multiple parents of a clade.

class Confidence (*type_=None, valueOf_=None*)

A general purpose confidence element. For example this can be used to express the bootstrap support value of a clade (in which case the 'type' attribute is 'bootstrap').

class Date (*unit=None, desc=None, value=None, minimum=None, maximum=None, valueOf_=None*)

A date associated with a clade/node. Its value can be numerical by using the 'value' element and/or free text with the 'desc' element' (e.g. 'Silurian'). If a numerical value is used, it is recommended to employ the 'unit' attribute to indicate the type of the numerical value (e.g. 'mya' for 'million years ago'). The elements 'minimum' and 'maximum' are used to indicate a range/confidence interval

class Distribution (*desc=None, point=None, polygon=None, valueOf_=None*)

The geographic distribution of the items of a clade (species, sequences), intended for phylogeographic applications. The location can be described either by free text in the 'desc' element and/or by the coordinates of one or more 'Points' (similar to the 'Point' element in Google's KML format) or by 'Polygons'.

class DomainArchitecture (*length=None, domain=None, valueOf_=None*)

This is used to describe the domain architecture of a protein. Attribute 'length' is the total length of the protein

class Events (*type_=None, duplications=None, speciations=None, losses=None, confidence=None, valueOf_=None*)

Events at the root node of a clade (e.g. one gene duplication).

class Id (*provider=None, valueOf_=None*)

A general purpose identifier element. Allows to indicate the provider (or authority) of an identifier.

class MolSeq (*is_aligned=None, valueOf_=None*)

Element 'mol_seq' is used to store molecular sequences. The 'is_aligned' attribute is used to indicate that this molecular sequence is aligned with all other sequences in the same phylogeny for which 'is aligned' is true as well (which, in most cases, means that gaps were introduced, and that all sequences for which 'is aligned' is true must have the same length).

class Phylogeny (*rerootable=None, branch_length_unit=None, type_=None, rooted=None, name=None, id=None, description=None, date=None, confidence=None, clade=None, clade_relation=None, sequence_relation=None, property=None, valueOf_=None*)

Element Phylogeny is used to represent a phylogeny. The required attribute 'rooted' is used to indicate whether the phylogeny is rooted or not. The attribute 'rerootable' can be used to indicate that the phylogeny is not allowed to be rooted differently (i.e. because it is associated with root

dependent data, such as gene duplications). The attribute ‘type’ can be used to indicate the type of phylogeny (i.e. ‘gene tree’). It is recommended to use the attribute ‘branch_length_unit’ if the phylogeny has branch lengths. Element `clade` is used in a recursive manner to describe the topology of a phylogenetic tree.

subclass

alias of `PhyloxmlTree`

class Point (*geodetic_datum=None, alt_unit=None, lat=None, long=None, alt=None, valueOf_=None*)

The coordinates of a point with an optional altitude (used by element ‘Distribution’). Required attributes are the ‘geodetic_datum’ used to indicate the geodetic datum (also called ‘map datum’, for example Google’s KML uses ‘WGS84’). Attribute ‘alt_unit’ is the unit for the altitude (e.g. ‘meter’).

class Polygon (*point=None, valueOf_=None*)

A polygon defined by a list of ‘Points’ (used by element ‘Distribution’).

class Property (*datatype=None, id_ref=None, ref=None, applies_to=None, unit=None, valueOf_=None, mixedclass_=None, content_=None*)

Property allows for typed and referenced properties from external resources to be attached to ‘Phylogeny’, ‘Clade’, and ‘Annotation’. The value of a property is its mixed (free text) content. Attribute ‘datatype’ indicates the type of a property and is limited to xsd-datatypes (e.g. ‘xsd:string’, ‘xsd:boolean’, ‘xsd:integer’, ‘xsd:decimal’, ‘xsd:float’, ‘xsd:double’, ‘xsd:date’, ‘xsd:anyURI’). Attribute ‘applies_to’ indicates the item to which a property applies to (e.g. ‘node’ for the parent node of a clade, ‘parent_branch’ for the parent branch of a clade). Attribute ‘id_ref’ allows to attached a property specifically to one element (on the xml-level). Optional attribute ‘unit’ is used to indicate the unit of the property. An example: `<property datatype="xsd:integer" ref="NOAA:depth" applies_to="clade" unit="METRIC:m"> 200 </property>`

class ProteinDomain (*to=None, confidence=None, fromxx=None, id=None, valueOf_=None*)

To represent an individual domain in a domain architecture. The name/unique identifier is described via the ‘id’ attribute. ‘confidence’ can be used to store (i.e.) E-values.

class Reference (*doi=None, desc=None, valueOf_=None*)

A literature reference for a clade. It is recommended to use the ‘doi’ attribute instead of the free text ‘desc’ element whenever possible.

class Sequence (*id_source=None, id_ref=None, type_=None, symbol=None, accession=None, name=None, location=None, mol_seq=None, uri=None, annotation=None, domain_architecture=None, valueOf_=None*)

Element `Sequence` is used to represent a molecular sequence (Protein, DNA, RNA) associated with a node. ‘symbol’ is a short (maximal ten characters) symbol of the sequence (e.g. ‘ACTM’) whereas ‘name’ is used for the full name (e.g. ‘muscle Actin’). ‘location’ is used for the location of a sequence on a genome/chromosome. The actual sequence can be stored with the ‘mol_seq’ element. Attribute ‘type’ is used to indicate the type of sequence (‘dna’, ‘rna’, or ‘protein’). One intended use for ‘id_ref’ is to link a sequence to a taxonomy (via the taxonomy’s ‘id_source’) in case of multiple sequences and taxonomies per node.

class SequenceRelation (*id_ref_0=None, id_ref_1=None, type_=None, distance=None, confidence=None, valueOf_=None*)

This is used to express a typed relationship between two sequences. For example it could be used to describe an orthology (in which case attribute ‘type’ is ‘orthology’).

class Taxonomy (*id_source=None, id=None, code=None, scientific_name=None, authority=None, common_name=None, synonym=None, rank=None, uri=None, valueOf_=None*)

Element Taxonomy is used to describe taxonomic information for a clade. Element 'code' is intended to store UniProt/Swiss-Prot style organism codes (e.g. 'APLCA' for the California sea hare 'Aplysia californica') or other styles of mnemonics (e.g. 'Aca'). Element 'authority' is used to keep the authority, such as 'J. G. Cooper, 1863', associated with the 'scientific_name'. Element 'id' is used for a unique identifier of a taxon (for example '6500' with 'ncbi_taxonomy' as 'provider' for the California sea hare). Attribute 'id_source' is used to link other elements to a taxonomy (on the xml-level).

class Uri (*type_=None, desc=None, valueOf_=None*)

A uniform resource identifier. In general, this is expected to be an URL (for example, to link to an image on a website, in which case the 'type' attribute might be 'image' and 'desc' might be 'image of a California sea hare').

class PhyloxmlTree (*phyloxml_clade=None, phyloxml_phylogeny=None, **kwargs*)

PhyloTree object supporting phyloXML format.

3.7 Seqgroup class

class SeqGroup (*sequences=None, format='fasta', fix_duplicates=True, **kwargs*)

Bases: object

SeqGroup class can be used to store a set of sequences (aligned or not).

Parameters

- **sequences** – Path to the file containing the sequences or, alternatively, the text string containing the same information.
- **format** (*fasta*) – the format in which sequences are encoded. Current supported formats are: *fasta*, *phylip* (*phylip* sequential) and *iphylip* (*phylip* interleaved). *Phylip* format forces sequence names to a maximum of 10 chars. To avoid this effect, you can use the relaxed *phylip* format: *phylip_relaxed* and *iphylip_relaxed*.

```
msf = ">seq1\nAAAAAAAAAAAA\n>seq2\nTTTTTTTTTTTTTT\n"  
seqs = SeqGroup(msf, format="fasta")  
print seqs.get_seq("seq1")
```

get_entries ()

Returns the list of entries currently stored.

get_seq (*name*)

Returns the sequence associated to a given entry name.

iter_entries ()

Returns an iterator over all sequences in the collection. Each item is a tuple with the sequence name, sequence, and sequence comments

set_seq (*name, seq, comments=None*)

Updates or adds a sequence

write (*format='fasta', outfile=None*)

Returns the text representation of the sequences in the supplied given format (default=FASTA). If “outfile” argument is used, the result is written into the given path.

New in version 2.1.

3.8 WebTreeApplication object

class WebTreeApplication

Provides a basic WSGI application object which can handle ETE tree visualization and interactions. Please, see the webplugin example provided with the ETE installation package (<http://pypi.python.org/pypi/ete2>).

register_action (*name, target, handler, checker, html_generator*)

Adds a new web interactive function associated to tree nodes.

set_default_layout_fn (*layout_fn*)

Fix the layout function used to render the tree.

set_external_app_handler (*handler*)

Sets a custom function that will extend current WSGI application.

set_external_tree_renderer (*handler*)

If the tree needs to be processed every time is going to be drawn, the task can be delegated.

set_tree_loader (*TreeConstructor*)

Delegate tree constructor. It allows to customize the Tree class used to create new tree instances.

set_tree_size (*w, h, units='px'*)

Fix the size of tree image

set_tree_style (*handler*)

Fix a TreeStyle instance to render tree images.

3.9 EvolTree class

class EvolNode (*newick=None, alignment=None, alg_format='fasta',
sp_naming_function=<function _parse_species>, format=0, binpath=''*)

Bases: `ete2.phylo.phylotree.PhyloNode`

Re-implementation of the standart TreeNode instance. It adds attributes and methods to work with phylogentic trees.

Parameters

- **newick** – path to tree in newick format, can also be a string
- **alignment** – path to alignment, can also be a string.
- **alg_format** (*fasta*) – alignment format.
- **sp_naming_function** – function to infer species name.
- **format** – type of newick format
- **binpath** – path to binaries, in case codeml or SLR are not in global path.

change_dist_to_evol (*evol, model, fill=False*)

change dist/branch length of the tree to a given evolutionary variable (dN, dS, w or bL), default is bL.

Parameters

- **evol** – evolutionary variable
- **model** – Model object from which to retrieve evolutionary variables
- **fill** (*False*) – do not affects only dist parameter, each node will be annotated with all evolutionary variables (node.dN, node.w...).

get_descendant_by_node_id (*idname*)

returns node list corresponding to a given idname

get_evol_model (*modelname*)

returns one precomputed model

Parameters **modelname** – string of the name of a model object stored

Returns Model object

get_most_likely (*altn, null*)

Returns pvalue of LRT between alternative model and null model.

usual comparison are:

Alternative	Null	Test
M2	M1	PS on sites (M2 prone to miss some sites) (Yang 2000)
M3	M0	test of variability among sites
M8	M7	PS on sites (Yang 2000)
M8	M8a	RX on sites?? think so....
bsA	bsA1	PS on sites on specific branch (Zhang 2005)
bsA	M1	RX on sites on specific branch (Zhang 2005)
bsC	M1	different omegas on clades branches sites ref: Yang Nielsen 2002
bsD	M3	different omegas on clades branches sites (Yang Nielsen 2002, Bielawski 2004)
b_free	b_neut	<p>foreground branch not neutral (w != 1)</p> <ul style="list-style-type: none"> • RX if $P < 0.05$ (means that w on $f_{rg}=1$) • PS if $P > 0.05$ and $w_{f_{rg}} > 1$ • CN if $P > 0.05$ and $w_{f_{rg}} > 1$ (Yang Nielsen 2002)
b_free	M0	different ratio on branches (Yang Nielsen 2002)

Parameters

- **altn** – model with higher number of parameters (np)
- **null** – model with lower number of parameters (np)

link_to_alignment (*alignment, alg_format='paml', nucleotides=True, **kwargs*)
 same function as for phyloTree, but translate sequences if nucleotides nucleotidic sequence is kept under node.nt_sequence

Parameters

- **alignment** (*True*) – path to alignment or string
- **alg_format** – one of fasta phylip or paml
- **alignment** – set to False in case we want to keep it untranslated

link_to_evolution_model (*path, model*)

link EvolTree to evolutionary model

- free-branch model ('fb') will append evol values to tree
- Site models (M0, M1, M2, M7, M8) will give evol values by site and likelihood

Parameters

- **path** – path to outfile containing model computation result
- **model** – either the name of a model, or a Model object (usually empty)

mark_tree (*node_ids*, *verbose=False*, ***kargs*)

function to mark branches on tree in order that paml could interpret it. takes a “marks” argument that should be a list of #1,#1,#2 e.g.:

```
t=Tree.mark_tree([2,3], marks=["#1", "#2"])
```

Parameters

- **node_ids** – list of node ids (have a look to node.node_id)
- **verbose** (*False*) – warn if marks do not correspond to codeml standard
- **kargs** – mainly for the marks key-word which needs a list of marks (marks=['#1', '#2'])

render (*file_name*, *layout=None*, *w=None*, *h=None*, *tree_style=None*, *header=None*, *histfaces=None*)

call super show adding up and down faces

Parameters

- **layout** – a layout function
- **tree_style** (*None*) – tree_style object
- **Nonehistface** – an histogram face function. This is only to plot selective pressure among sites

run_model (*model_name*, *ctrl_string=''*, *keep=True*, ***kwargs*)

To compute evolutionary models. e.g.: b_free_lala.vs.lele, will launch one free branch model, and store it in “WORK_DIR/b_free_lala.vs.lele” directory

WARNING: this functionality needs to create a working directory in “rep”

WARNING: you need to have codeml and/or SLR in your path

The models available are:

Model name	Description	Model kind
M1	relaxation	site
M10	beta and gamma + 1	site
M11	beta and normal > 1	site
M12	0 and 2 normal > 2	site
M13	3 normal > 0	site
M2	positive-selection	site
M3	discrete	site
M4	frequencies	site
M5	gamma	site
M6	2 gamma	site
M7	relaxation	site
M8	positive-selection	site
M8a	relaxation	site
M9	beta and gamma	site
SLR	positive/negative selection	site
M0	negative-selection	null
fb_anc	free-ratios	branch_ancestor
bsA	positive-selection	branch-site
bsA1	relaxation	branch-site
bsB	positive-selection	branch-site
bsC	different-ratios	branch-site
bsD	different-ratios	branch-site
b_free	positive-selection	branch
b_neut	relaxation	branch
fb	free-ratios	branch

Parameters

- **model_name** – a string like “model-name[some-secondary-name]” (e.g.: “fb.my_first_try”, or just “fb”) * model-name is compulsory, is the name of the model (see table above for the full list) * the second part is accessory, it is to avoid over-writing models with the same name.
- **ctrl_string** – list of parameters that can be used as control file.
- **kwargs** – extra parameters should be one of: verbose, CodonFreq, ncatG, cleandata, fix_blength, NSSites, fix_omega, clock, seqfile, runmode, fix_kappa, fix_alpha, Small_Diff, method, Malpha, aaDist, RateAncestor, outfile, icode, alpha, seqtype, omega, getSE, noisy, Mgene, kappa, treefile, model, ndata.

sep = ‘\n’

show (*layout=None, tree_style=None, histfaces=None*)

call super show of PhyloTree histface should be a list of models to be displayed as histfaces

Parameters

- **layout** – a layout function
- **tree_style** (*None*) – tree_style object
- **Nonehistface** – an histogram face function. This is only to plot selective pressure among sites

write (*features=None, outfile=None, format=10*)

Inherits from Tree but adds the tenth format, that allows to display marks for CodeML.
TODO: internal writing format need to be something like 0

Returns the newick representation of current node. Several arguments control the way in which extra data is shown for every node:

Parameters

- **features** – a list of feature names to be exported using the Extended Newick Format (i.e. features=["name", "dist"]). Use an empty list to export all available features in each node (features=[])
- **outfile** – writes the output to a given file
- **format** (*10*) – defines the newick standard used to encode the tree. See tutorial for details.
- **format_root_node** (*False*) – If True, it allows features and branch information from root node to be exported as a part of the newick text string. For newick compatibility reasons, this is False by default.
- **is_leaf_fn** – See `TreeNode.traverse()` for documentation.

Example:

```
t.get_newick(features=["species","name"], format=1)
```

EvolTree

alias of EvolNode

3.10 NCBITaxa class

class NCBITaxa (*dbfile=None*)

Bases: object

versionadded: 2.3

Provides a local transparent connector to the NCBI taxonomy database.

annotate_tree (*t, taxid_attr='name', tax2name=None, tax2track=None, tax2rank=None*)

Annotate a tree containing taxids as leaf names by adding the 'taxid', 'sci_name', 'lineage', 'named_lineage' and 'rank' additional attributes.

Parameters

- **t** – a Tree (or Tree derived) instance.
- **taxid_attr** (*name*) – Allows to set a custom node attribute containing the taxid number associated to each node (i.e. species in PhyloTree instances).

Parameters tax2name, tax2track, tax2rank – Use these arguments to provide

pre-calculated dictionaries providing translation from taxid number and names, track lineages and ranks.

get_broken_branches (*t, taxa_lineages, n2content=None*)

Returns a list of NCBI lineage names that are not monophyletic in the provided tree, as well as the list of affected branches and their size.

CURRENTLY EXPERIMENTAL

get_common_names (*taxids*)

get_descendant_taxa (*parent, intermediate_nodes=False, rank_limit=None, collapse_subspecies=False, return_tree=False*)

given a parent taxid or scientific species name, returns a list of all its descendants taxids. If *intermediate_nodes* is set to True, internal nodes will also be dumped.

get_fuzzy_name_translation (*name, sim=0.9*)

Given an inexact species name, returns the best match in the NCBI database of taxa names.

Parameters *sim* (0.9) – Min word similarity to report a match (from 0 to 1).

Returns taxid, species-name-match, match-score

get_lineage (*taxid*)

Given a valid taxid number, return its corresponding lineage track as a hierarchically sorted list of parent taxids.

get_name_translator (*names*)

Given a list of taxid scientific names, returns a dictionary translating them into their corresponding taxids.

Exact name match is required for translation.

get_rank (*taxids*)

return a dictionary converting a list of taxids into their corresponding NCBI taxonomy rank

get_taxid_translator (*taxids*)

Given a list of taxids, returns a dictionary with their corresponding scientific names.

get_topology (*taxids, intermediate_nodes=False, rank_limit=None, collapse_subspecies=False, annotate=True*)

Given a list of taxid numbers, return the minimal pruned NCBI taxonomy tree containing all of them.

Parameters *intermediate_nodes* (*False*) – If True, single child nodes

representing the complete lineage of leaf nodes are kept. Otherwise, the tree is pruned to contain the first common ancestor of each group.

Parameters *rank_limit* (*None*) – If valid NCBI rank name is provided, the tree is

pruned at that given level. For instance, use *rank="species"* to get rid of sub-species or strain leaf nodes.

Parameters *collapse_subspecies* (*False*) – If True, any item under the species

rank will be collapsed into the species upper node.

translate_to_names (*taxids*)

Given a list of taxid numbers, returns another list with their corresponding scientific names.

update_taxonomy_database (*taxdump_file=None*)

Updates the ncbi taxonomy database by downloading and parsing the latest taxdump.tar.gz file from the NCBI FTP site.

Parameters **taxdump_file** (*None*) – an alternative location of the tax-dump.tax.gz file.

genindex

modindex

[yang2007] Yang, Z., PAML 4: phylogenetic analysis by maximum likelihood. *Molecular biology and evolution* 24: 1586-91. (2007)

[massingham2005] Massingham T. and Goldman N. Detecting amino acid sites under positive selection and purifying selection. *Genetics* 169: 1853-1762. (2005)

e

ete2, 13
ete2.clustering, 80
ete2.evol, 161
ete2.ncbi_taxonomy, 166
ete2.nexml, 141
ete2.parser.seggroup, 160
ete2.phylo, 137
ete2.phyloxml, 157
ete2.treeview, 127
ete2.webplugin, 92

A

add_child() (TreeNode method), 115
 add_face() (FaceContainer method), 129
 add_face() (TreeNode method), 116
 add_face_to_node() (in module ete2), 130
 add_feature() (TreeNode method), 116
 add_features() (TreeNode method), 116
 add_sister() (TreeNode method), 116
 annotate_ncbi_taxa() (PhyloNode method), 137
 annotate_tree() (NCBITaxa method), 166
 AttrFace (class in ete2), 131

B

BarChartFace (class in ete2), 134
 build_from_file() (Nexml method), 142

C

change_dist_to_evol() (EvolNode method), 161
 check_monophyly() (TreeNode method), 116
 children (TreeNode attribute), 116
 CircleFace (class in ete2), 132
 ClusterNode (class in ete2), 140
 ClusterTree (in module ete2), 141
 collapse_lineage_specific_expansions() (PhyloNode method), 138
 COLOR_SCHEMES (in module ete2), 136
 compare() (TreeNode method), 117
 convert_to_ultrametric() (TreeNode method), 117
 copy() (TreeNode method), 117

D

del_feature() (TreeNode method), 117
 delete() (TreeNode method), 117
 describe() (TreeNode method), 118
 detach() (TreeNode method), 118
 dist (TreeNode attribute), 118
 DynamicItemFace (class in ete2), 135

E

ete2 (module), 13, 108

ete2.clustering (module), 80, 140
 ete2.evol (module), 161
 ete2.ncbi_taxonomy (module), 166
 ete2.nexml (module), 141
 ete2.parser.seqgroup (module), 160
 ete2.phylo (module), 137
 ete2.phyloxml (module), 157
 ete2.treeview (module), 127
 ete2.webplugin (module), 92, 161
 EvolEvent (class in ete2.phylo), 140
 EvolNode (class in ete2), 161
 EvolTree (in module ete2), 166
 expand_polytomies() (TreeNode method), 118

F

Face (class in ete2), 130
 FaceContainer (class in ete2), 129

G

get_age() (PhyloNode method), 138
 get_age_balanced_outgroup() (PhyloNode method), 138
 get_ancestors() (TreeNode method), 118
 get_ascii() (TreeNode method), 118
 get_broken_branches() (NCBITaxa method), 166
 get_cached_content() (TreeNode method), 118
 get_children() (TreeNode method), 118
 get_closest_leaf() (TreeNode method), 119
 get_common_ancestor() (TreeNode method), 119
 get_common_names() (NCBITaxa method), 167
 get_descendant_by_node_id() (EvolNode method), 162
 get_descendant_evol_events() (PhyloNode method), 138
 get_descendant_taxa() (NCBITaxa method), 167
 get_descendants() (TreeNode method), 119
 get_distance() (TreeNode method), 119
 get_dunn() (ClusterNode method), 141
 get_edges() (TreeNode method), 119
 get_entries() (SeqGroup method), 160

- get_evol_model() (EvolNode method), 162
 - get_farthest_leaf() (TreeNode method), 119
 - get_farthest_node() (TreeNode method), 120
 - get_farthest_oldest_leaf() (PhyloNode method), 139
 - get_farthest_oldest_node() (PhyloNode method), 139
 - get_fuzzy_name_translation() (NCBITaxa method), 167
 - get_leaf_names() (TreeNode method), 120
 - get_leaf_profiles() (ClusterNode method), 141
 - get_leaves() (TreeNode method), 120
 - get_leaves_by_name() (TreeNode method), 120
 - get_lineage() (NCBITaxa method), 167
 - get_midpoint_outgroup() (TreeNode method), 120
 - get_monophyletic() (TreeNode method), 120
 - get_most_likely() (EvolNode method), 162
 - get_my_evol_events() (PhyloNode method), 139
 - get_name_translator() (NCBITaxa method), 167
 - get_rank() (NCBITaxa method), 167
 - get_seq() (SeqGroup method), 160
 - get_silhouette() (ClusterNode method), 141
 - get_sisters() (TreeNode method), 120
 - get_speciation_trees() (PhyloNode method), 139
 - get_species() (PhyloNode method), 139
 - get_taxid_translator() (NCBITaxa method), 167
 - get_topology() (NCBITaxa method), 167
 - get_topology_id() (TreeNode method), 120
 - get_tree_root() (TreeNode method), 120
- ## H
- hoverEnterEvent() (SequenceFace.InteractiveLetterItem method), 133
 - hoverLeaveEvent() (SequenceFace.InteractiveLetterItem method), 133
- ## I
- img_style (TreeNode attribute), 121
 - ImgFace (class in ete2), 132
 - is_leaf() (TreeNode method), 121
 - is_root() (TreeNode method), 121
 - iter_ancestors() (TreeNode method), 121
 - iter_descendants() (TreeNode method), 121
 - iter_edges() (TreeNode method), 121
 - iter_entries() (SeqGroup method), 160
 - iter_leaf_names() (TreeNode method), 121
 - iter_leaf_profiles() (ClusterNode method), 141
 - iter_leaves() (TreeNode method), 121
 - iter_prepostorder() (TreeNode method), 121
 - iter_search_nodes() (TreeNode method), 121
 - iter_species() (PhyloNode method), 139
- ## L
- ladderize() (TreeNode method), 121
 - link_to_alignment() (EvolNode method), 163
 - link_to_alignment() (PhyloNode method), 139
 - link_to_arraytable() (ClusterNode method), 141
 - link_to_evol_model() (EvolNode method), 163
- ## M
- mark_tree() (EvolNode method), 164
- ## N
- ncbi_compare() (PhyloNode method), 139
 - NCBITaxa (class in ete2), 166
 - Nexml (class in ete2), 142
 - NexmlTree (class in ete2), 142
 - NodeStyle (class in ete2), 129
- ## P
- PhyloNode (class in ete2), 137
 - PhyloTree (in module ete2), 140
 - Phyloxml (class in ete2), 157
 - PhyloxmlTree (class in ete2), 157
 - PieChartFace (class in ete2), 134
 - populate() (TreeNode method), 122
 - ProfileFace (class in ete2), 135
 - prune() (TreeNode method), 122
- ## R
- random_color() (in module ete2), 137
 - reconcile() (PhyloNode method), 139
 - RectFace (class in ete2), 132
 - register_action() (WebTreeApplication method), 161
 - remove_child() (TreeNode method), 124
 - remove_sister() (TreeNode method), 124
 - render() (EvolNode method), 164
 - render() (TreeNode method), 124
 - resolve_polytomy() (TreeNode method), 124
 - robinson_foulds() (TreeNode method), 124
 - run_model() (EvolNode method), 164
- ## S
- search_nodes() (TreeNode method), 125
 - sep (EvolNode attribute), 165
 - SeqGroup (class in ete2), 160
 - SeqMotifFace (class in ete2), 133
 - SequenceFace (class in ete2), 132
 - SequenceFace.InteractiveLetterItem (class in ete2), 133

set_default_layout_fn() (WebTreeApplication method), 161
set_distance_function() (ClusterNode method), 141
set_external_app_handler() (WebTreeApplication method), 161
set_external_tree_renderer() (WebTreeApplication method), 161
set_outgroup() (TreeNode method), 125
set_seq() (SeqGroup method), 160
set_species_naming_function() (PhyloNode method), 140
set_style() (TreeNode method), 125
set_tree_loader() (WebTreeApplication method), 161
set_tree_size() (WebTreeApplication method), 161
set_tree_style() (WebTreeApplication method), 161
show() (EvolNode method), 165
show() (TreeNode method), 125
sort_descendants() (TreeNode method), 125
species (PhyloNode attribute), 140
split_by_dups() (PhyloNode method), 140
StackedBarFace (class in ete2), 132
standardize() (TreeNode method), 125
StaticItemFace (class in ete2), 135
support (TreeNode attribute), 126
SVG_COLORS (in module ete2), 136
swap_children() (TreeNode method), 126

T

TextFace (class in ete2), 131
translate_to_names() (NCBITaxa method), 167
traverse() (TreeNode method), 126
Tree (in module ete2), 126
TreeFace (class in ete2), 135
TreeNode (class in ete2), 115
TreeStyle (class in ete2), 127

U

unroot() (TreeNode method), 126
up (TreeNode attribute), 126
update_taxonomy_database() (NCBITaxa method), 167

W

WebTreeApplication (class in ete2), 161
write() (EvolNode method), 166
write() (SeqGroup method), 160
write() (TreeNode method), 126